

ERKADO Doors



ERKADO
www.erkado.pl

This block features the ERKADO logo, which consists of three horizontal lines to the left of the brand name. Below the logo is the website address. To the right of the text is a small inset image showing a modern interior with a white sofa and a wooden door.





LOCATION



GOŚCIERADÓW
40 THS. M² FACTORY

POLAND

EUROPE

ERKADO



WHO WE ARE?

 **ERKADO**

MANUFACTURER OF



INTERIOR DOORS



EXTERIOR DOORS



DOOR FRAMES



ACCESSORIES



HISTORY & MISSION

 **ERKADO**

EXPERIENCE

STRONG
FAMILY
TRADITION

40
YEARS

OPERATION



STAFF



OVER 500 EMPLOYEES



SPECIALISTS - PASSIONATES



INTELLECTUAL VALUE



ERKADO



**OUR
TECHNICAL
ADVANTAGE**

ERKADO





HIGH-TECH ROBOTS

 ERKADO

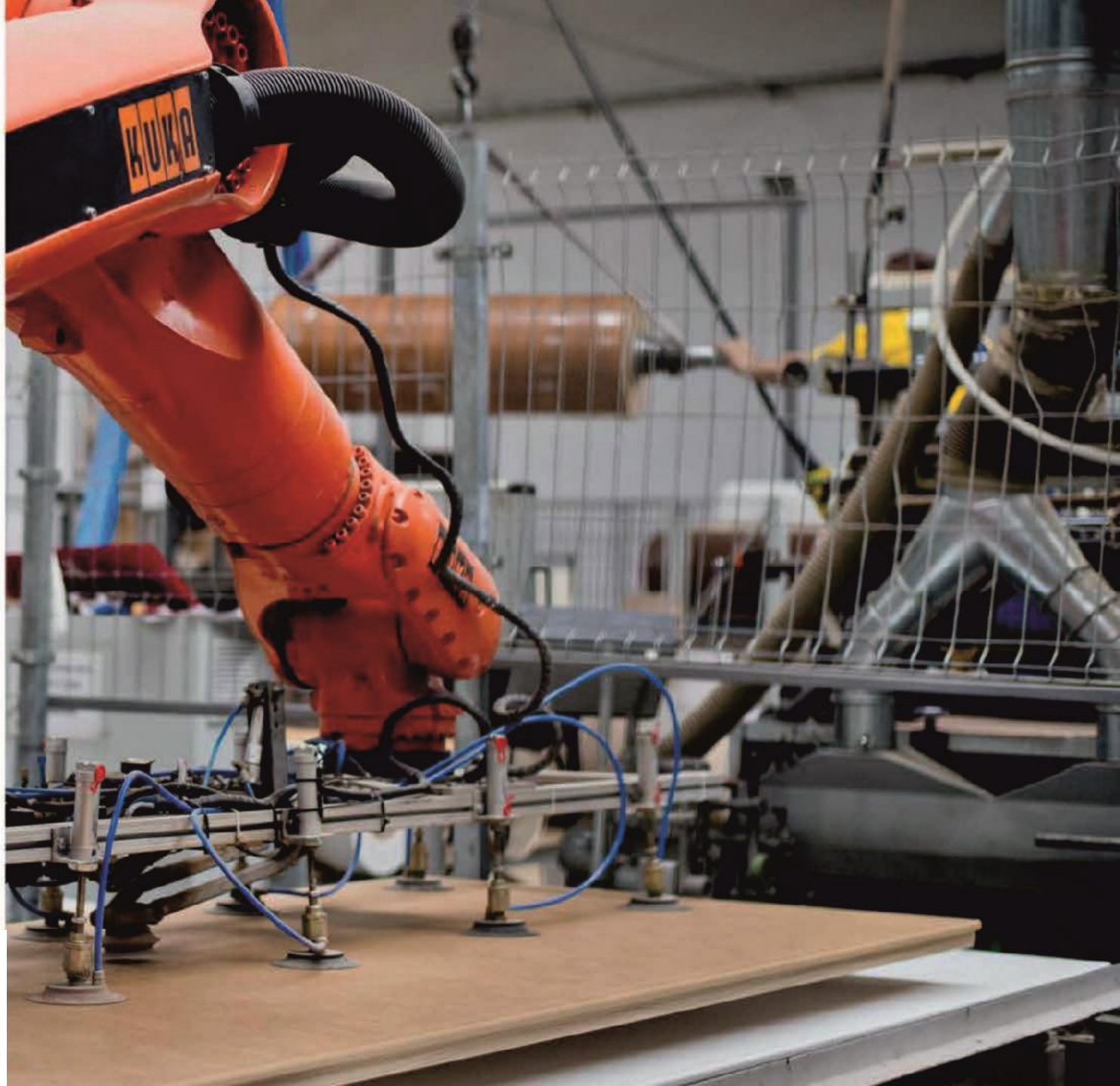

INCOMES

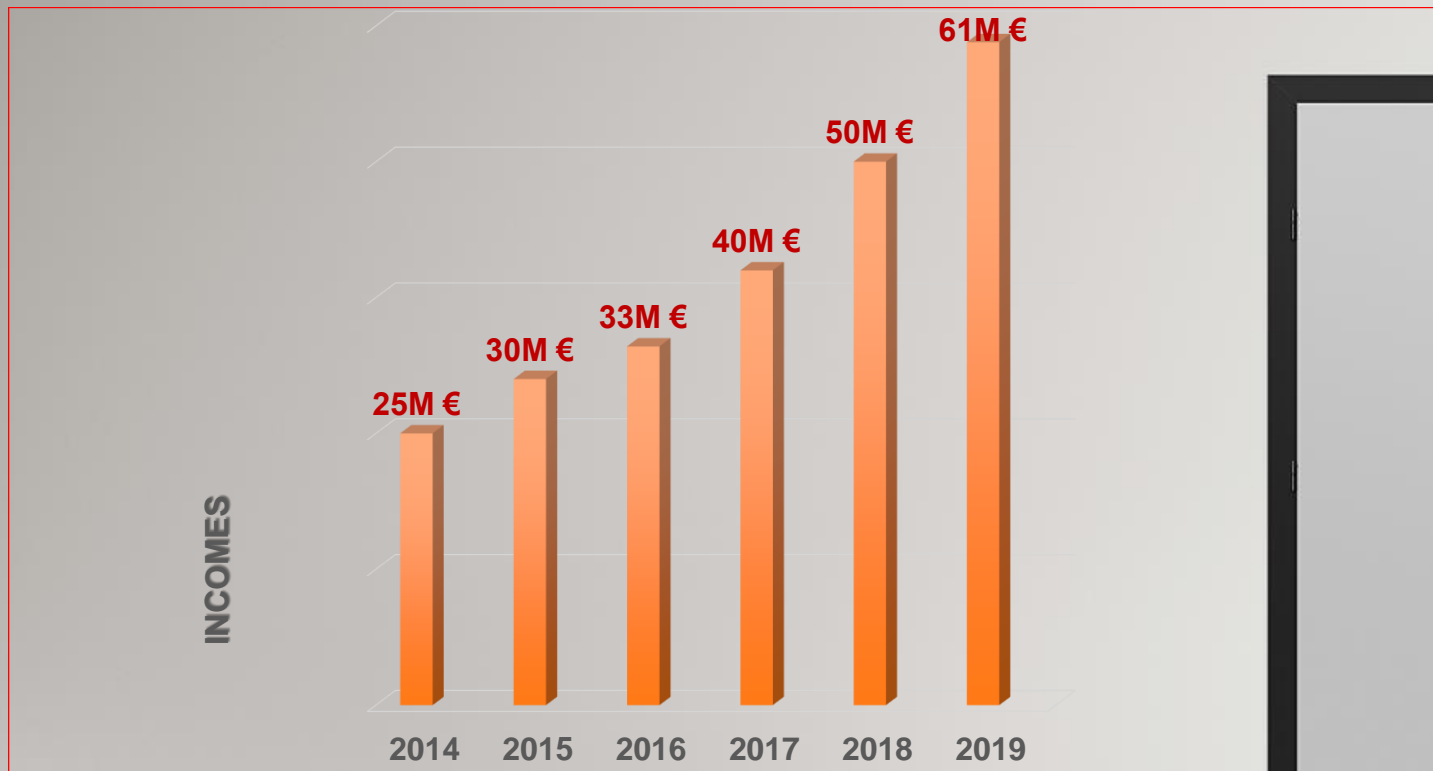

**How our
company looks
like ...**



ERKADO

How our
company looks
like ...



How our
company looks
like ...



How our
company looks
like ...



 ERKADO

How looks like
our company...



How looks like
our company...

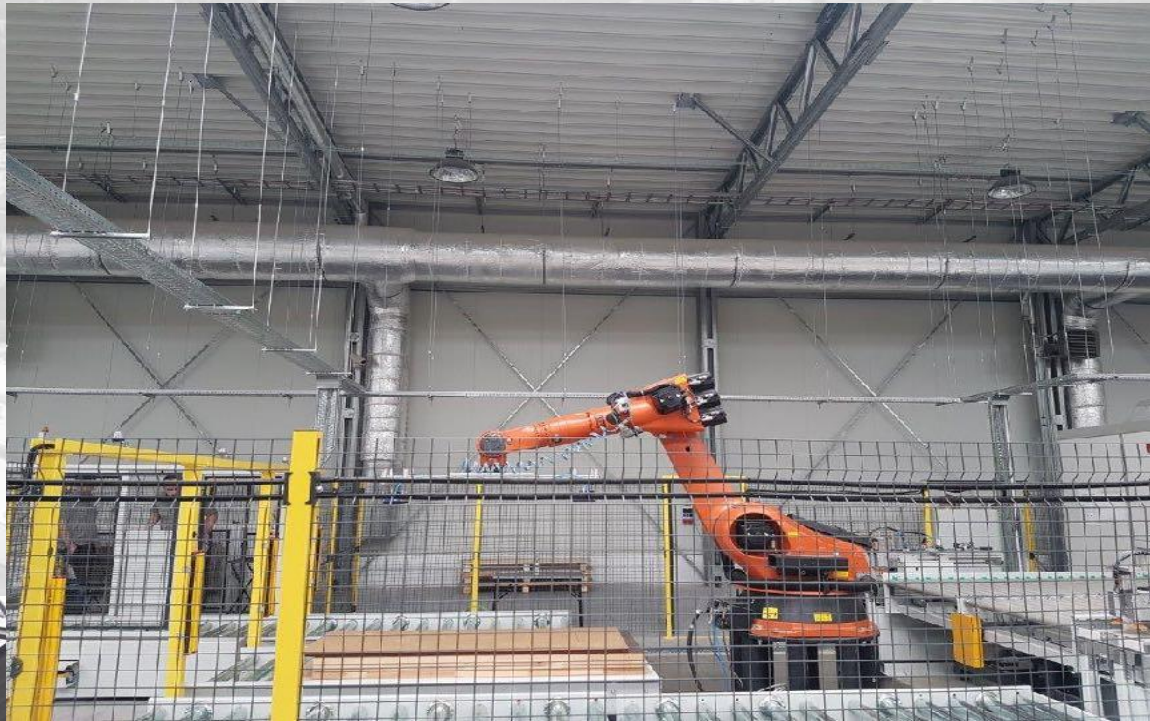

 ERKADO

ERKADO

ALL OVER THE WORLD

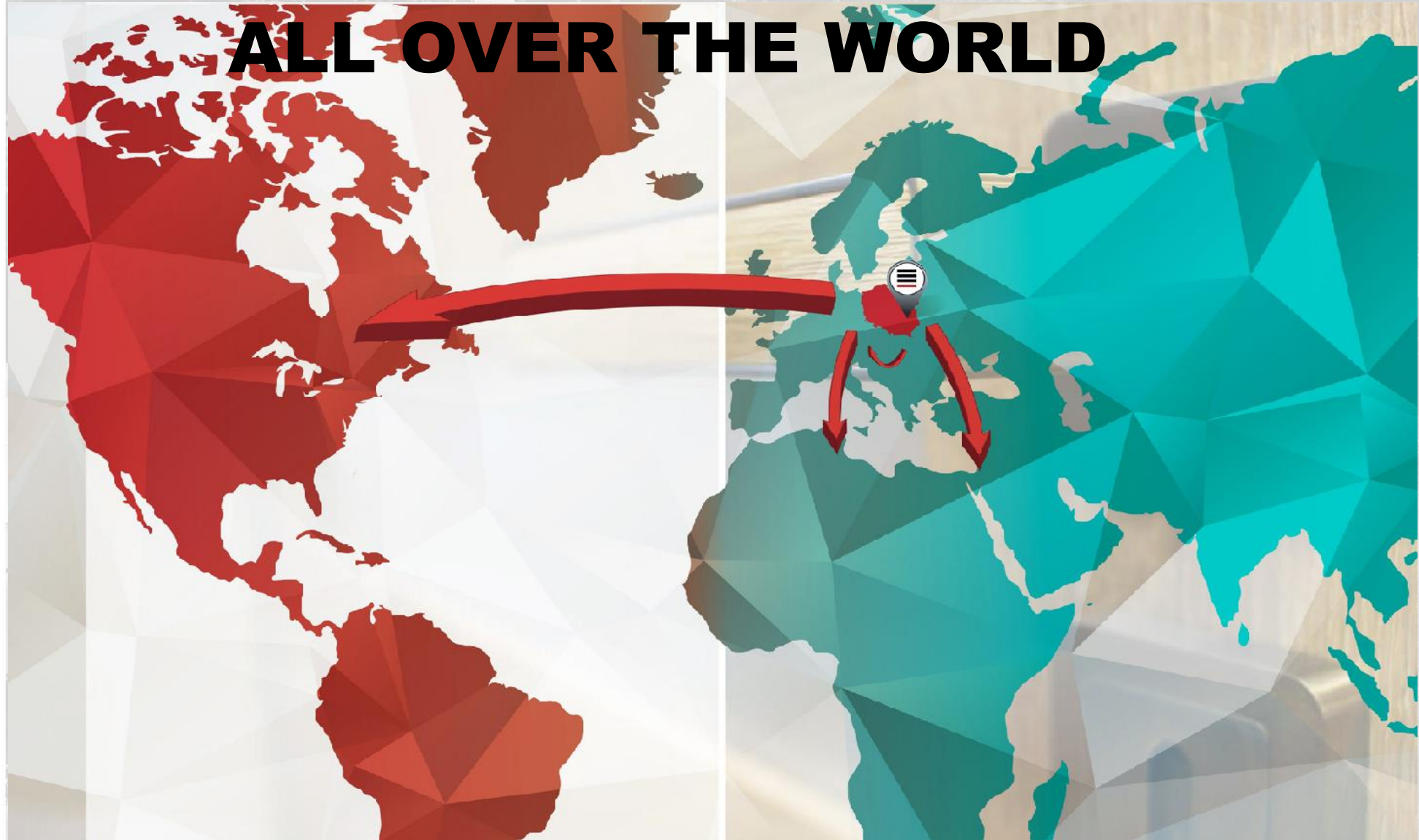

Selected countries:

- United States
- Bulgaria
- Romania
- Czech Republic
- Slovakia
- Hungary
- Greece
- France
- Lithuania
- Slovenia
- Italy
- Malta
- Canada
- And many more

 ERKADO

OUR TECHNOLOGIES



STILE - interior doors



BOARD - interior doors



HERSE - interior entrance doors



LEDA - interior fire resistant doors



GRAF - glass doors

60 K

PIECES OF
INTERIOR DOORS

55 K

PIECES OF
DOOR FRAMES

STILE - interior doors



SOLID RAIL 22
mm THICK



ESTHETIC PROFILED
NON-RAIL GLAZING



MODERN GREKO FINISH



MODERN TAMPERED
GLASS MILK OR
INNOVATIVE VSG MATT
GLASS

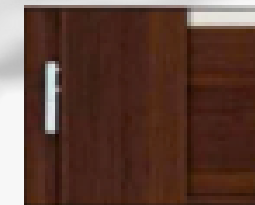

THREE PRACTICAL
SCREW PINTLE
REGULATED HINGES
SET IN MASSIVE
VERTICAL RAIL 40 mm
THICK



SOLID TENON
CONNECTIONS

STILE - interior doors



BOARD – interior doors

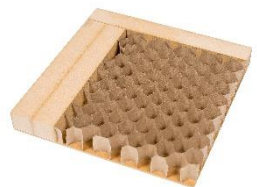

ERKADO



BOARD – interior doors



PAINTED –
UV lasquered doors



GRAF- glass doors

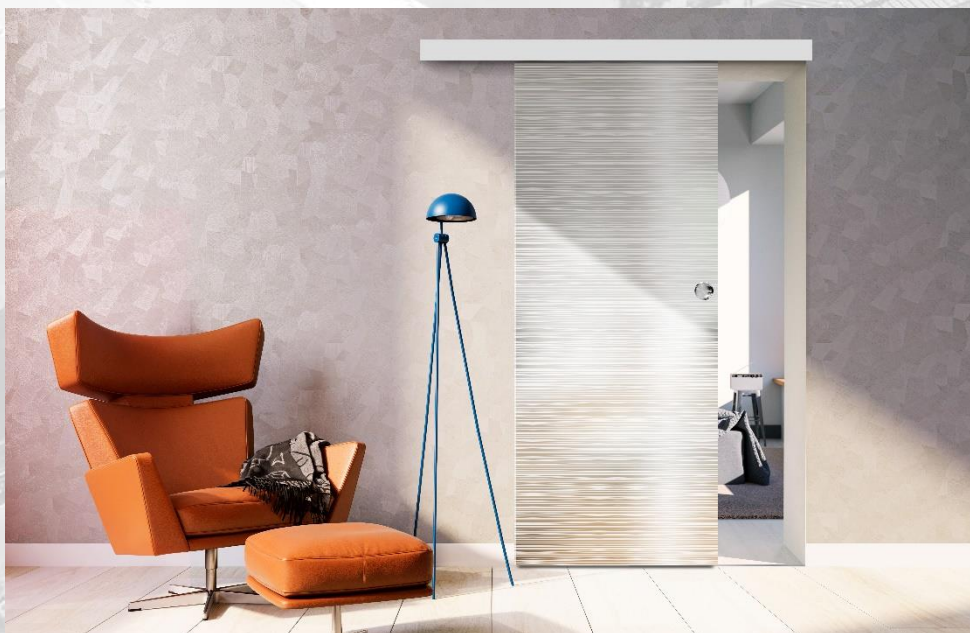

SLIDING DOORS

on-wall, in-wall



LOFT doors



HERSE

Interior
entrance doors



ERKADO

FORTECA-

security doors
RC2 and RC3

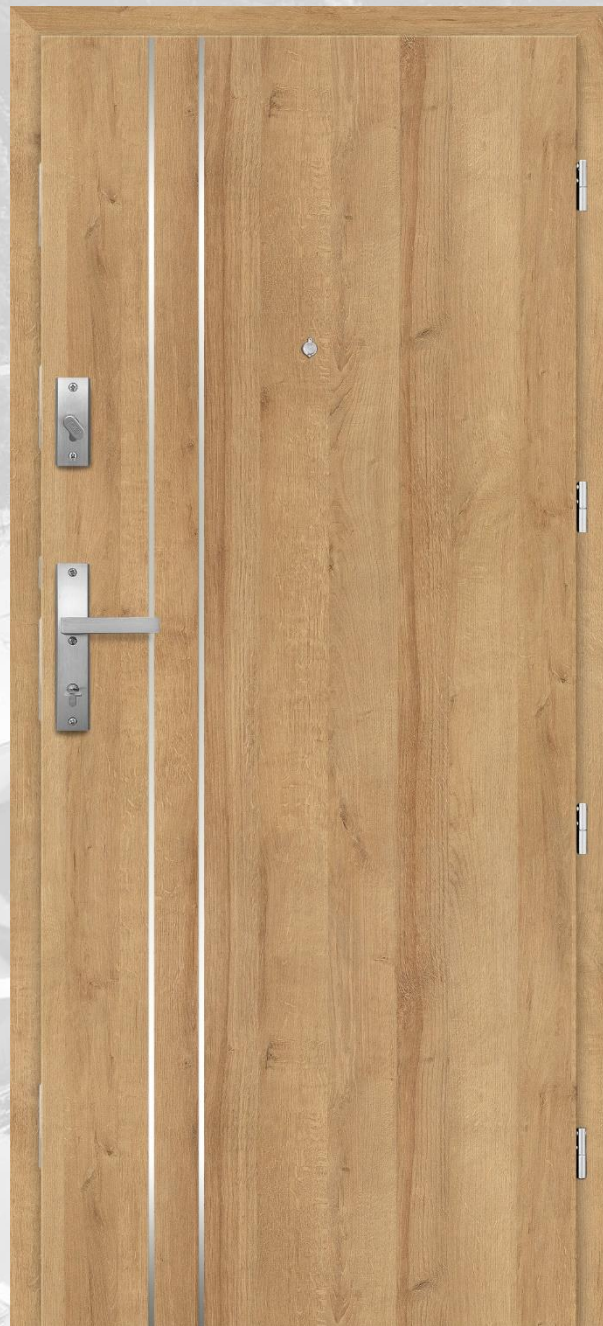
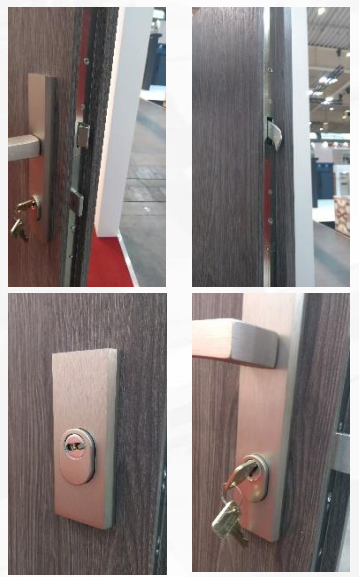

FORTECA RC2 & RC3



RC2 & RC3 BURGLARPROOF ENTRANCE DOORS



2 HOOK BOLTS



UPPER AND LOWER SECURITY LOCKS



FOUR DOOR STRIKER PLATES Adjustable

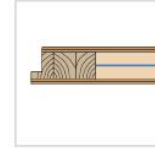

DOOR LEAF 46 mm Steel sheet reinforced



MULTIPOINT LOCK



LOWEISCHENWEL 37dB



FOUR 2-PIN HINGES; Ø16, 3D ADJUSTABLE



4 HINGE BOLTS



FIXED DOOR FRAME Timber frame in RC2; Reinforced frame in RC3



HARDWOOD TRESHOLD (lacquer)



FORTECA RC2



FORTECA RC3



DOOR VIEWER



STAINLESS STEEL TRESHOLD

FORTECA DOOR LEAF CROSS-SECTION

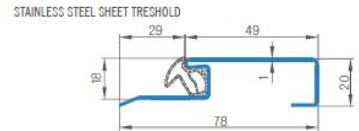
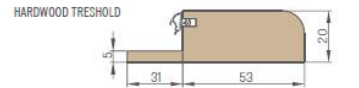
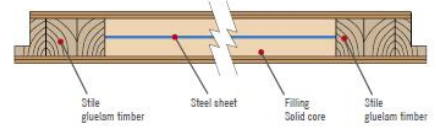

LEDA-

fire rated doors
Ei30, Ei60

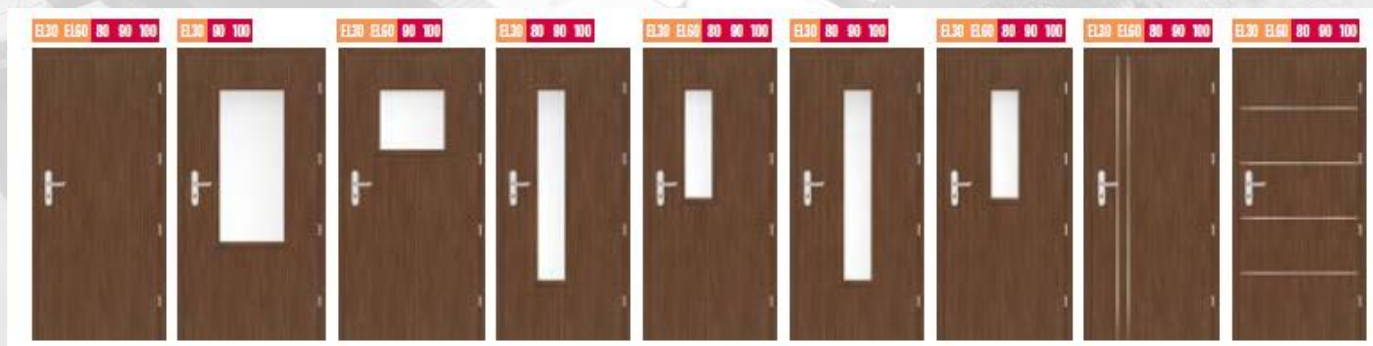

HIDDEN – Interior doors

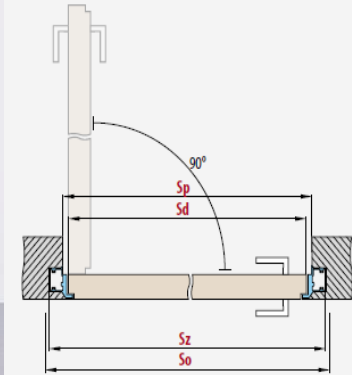
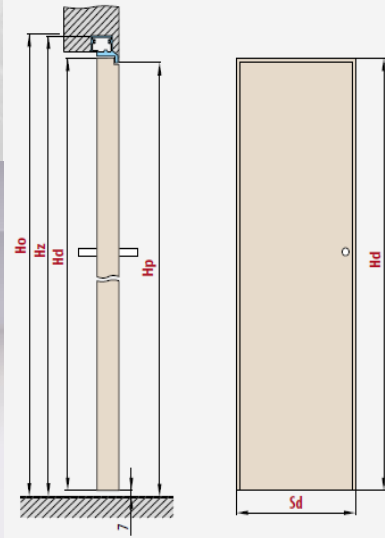

■ INTERSECTION OF ALUMINIUM FRAME

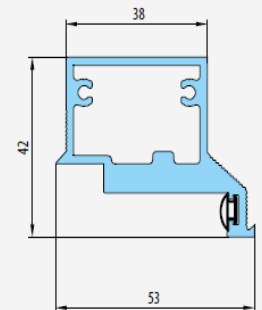

ERKADO

ERKADO

Portfolio:



EXTERIOR - solid wooden doors





OUR STRENGTH

ERKADO
today

Over 40 years of experience	Over 150 models
around 60 000 door per month	300 external doors
30 distributors in Poland	3 000 APS (Authorized Points of Sale)
83 abroad distrobuitors	28 countries
150 new employees in 2018/2019	Over 550 specialists employed-

OUR STRENGTH



ERKADO
today



ERKADO
today

OUR STRENGTH



- Individual approach to the client - **flexibility**.
- **Modern technologies** used for production.
- **Short deadline**.
- Friendly service with **fast response time**.
- **Family business** - fast decision-making - saving time.
- The combination of very good quality with very affordable prices - **excellent balance**.
- **Modern system solutions in the b2b**

„Quality is never an accident.
It is always the result of
intelligent effort.”

John Ruskin

Earn money with 

Radek Bartochowski
Export Director
r.bartochowski@erkado.pl
+48 532 106 922



