

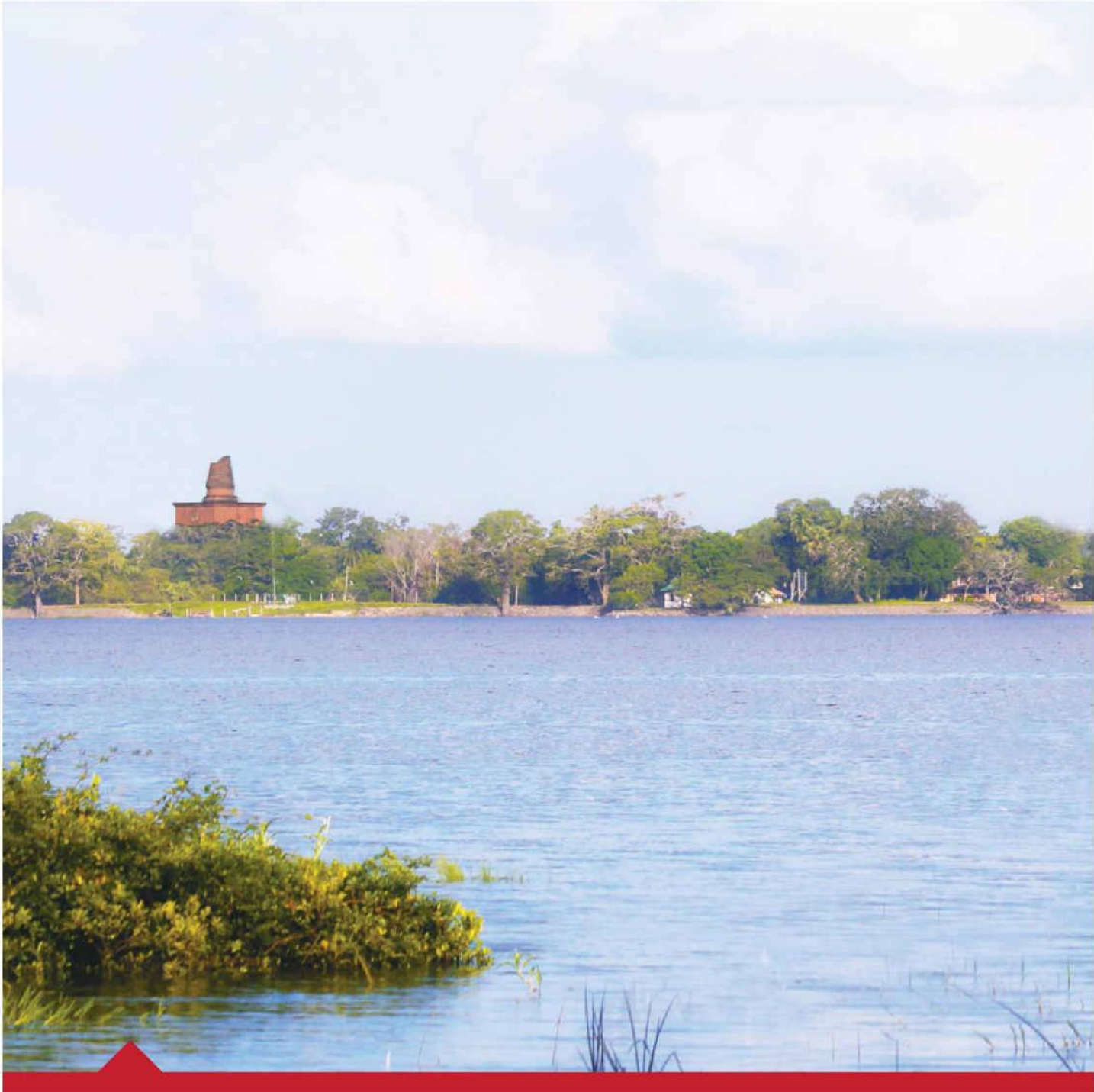

ROOF TILE CATALOGUE

Discover Solid Elegance





“DSI Samson Group”, is one of the largest conglomerates in Sri Lanka that values the county’s heritage. It is proud to be associated with the ancient city; Anuradhapura, which belongs to the historical Rajarata region.

The group’s subsidiary ‘Rajarata Tiles’ is named after this sovereign expanse that once sustained many kingdoms. By claiming its origins from the age-old Natchchaduwa reservoir built by king Mahasen, the Rajarata Tile efficiently serves the country whilst representing its legacy overseas.



ABOUT US

Samson Rajarata Tiles (Pvt) Ltd., is a subsidiary of the DSI Samson group, a well recognized conglomerate in Sri Lanka renowned for its manufacturing acumen.

Our products reflect creativity and design, tradition and culture and are manufactured according to international standards. We provide an extensive choice of styles of clay roofing tiles ranging from 'Spanish' to 'Roman', 'Flat' to 'Covering' and 'S-shaped' together with free island wide delivery.



RAJARATA
TILES

OUR CLAY & TECHNOLOGY

Quality assured, Samson Rajarata tiles are recognized for their unparalleled strength. The tiles are manufactured using a globally recognized Japanese technology. We guarantee our clay tiles to,

- have zero leakage
- withstand high temperatures
- meet international standards
- maintain energy efficiency by reflecting heat during summer and insulation during cold weather.

Colour personalization services are available on request.

OUR ENVIRONMENT, OUR COMMUNITY

Clay for Samson Rajarata tiles are sourced from the desilting process of the Nachchaduwa tank situated in the ancient city of Anuradhapura in Sri Lanka. The desilting process helps the tank retain water and prevents overflow, benefitting the immediate community.



WHY WE ARE EXCEPTIONAL & DIFFERENT

1



PROCESSED CLAY (NATURAL)

2



WATER ABSORPTION (>10%)

3

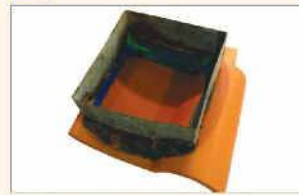

PERMEABILITY (NO FORMATION OF WATER DROPLETS WITHIN 24 HOURS)

4



BREAKING STRENGTH (< 1000N/mm²)

5



UNIQUE INTERLOCKING SYSTEM

6



MONKEY PROOF (FIRMLY NAILED TO REEPERS)

**RAJARATA**
TILES



■ PRODUCT RANGE

An array of designs

1 "S" TILE



2 SPANISH TILE



3 FLAT TILE



4 ROMAN TILE



5 COVERING TILE



6 HELA TILE



7 TERRACOTA FLOOR TILE



**RAJARATA**
TILES



1. "S" TILE

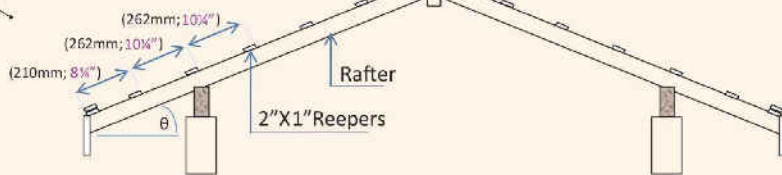
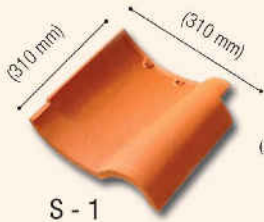

Minimum roof angle (θ) = 25°

Tile Specifications

Length	310 mm \pm 3 mm
Width	310 mm \pm 3 mm
Effective Length	260 mm \pm 2 mm
Effective Width	250 mm \pm 3 mm
Unit Weight	3.1 kg \pm 0.05 kg
Water Absorption	>10%
Transverse Breaking Load	<1000N/mm ²
Coverage	140 tiles per 100 sq.ft
Water Permeability	No formation of water droplets within 24 hours

ACCESSORIES



RIDGE TILE- S2



GABLE RIGHT- S4



GABLE LEFT- S3



CORNER TILE- S5

RAJARATA
TILES



■ ROOF STRUCTURE - "S"

06. Ridge Tile Identification

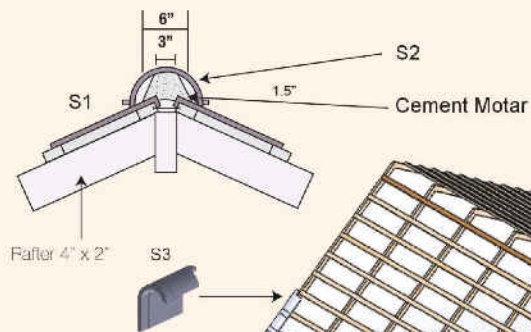

Rafter Specifications

Rafter Section	4" X 2"	5" X 2"	6" X 2"
Roof Angle(θ)	Rafter Span (L)		
25° Minimum	8'	8' to 12'	8' to 12'
25° and above	8'	8' to 10'	8' to 12'

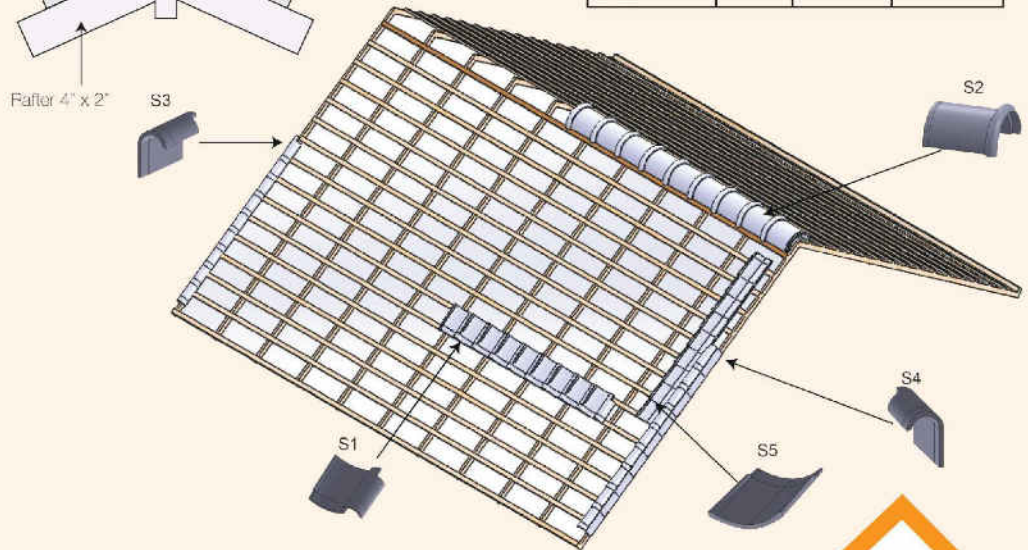

RAJARATA
TILES

COLOUR RANGE



S-Black Matt



S-Coffee Brown



S-Syres



S-Blue



S-Green



S-Off White



S-Gray



S-Autumn Blend



RAJARATA
TILES



2. SPANISH TILE

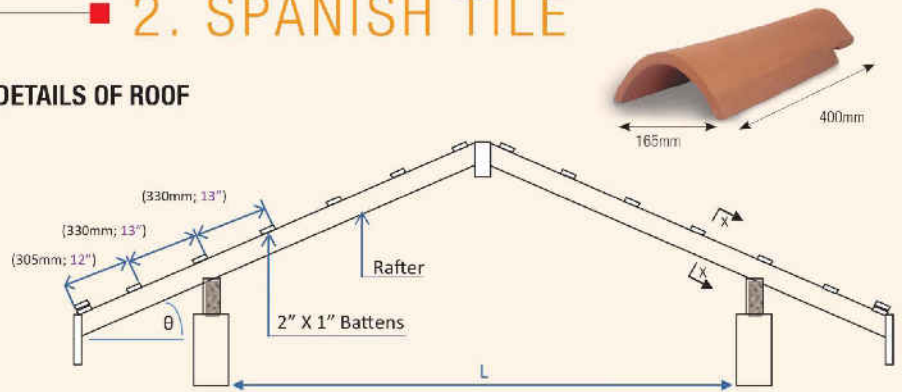

DETAILS OF ROOF



Minimum roof angle (θ) = 25°
 Maximum roof angle (θ) = 40°

Tile Specifications

Length	400±3mm
Width	165±5mm
Effective Length	330±3mm
Effective Width	98±3mm
Unit Weight	2.0±0.05kg
Transverse Breaking Load	Above 1000 N/mm ²
Coverage	290 pcs. Per 100 sq. Feet
Water Absorption	Less than 10%
Water Permeability	No formation of water droplets within 24 hours

Rafter Specifications

Rafter Section	4" X 2"	5" X 2"	6" X 2"
Roof Angle(θ)	Rafter Span (L)		
25° Minimum	8'	8' to 12'	8' to 12'
25° and above	8'	8' to 10'	8' to 12'



3. FLAT TILE

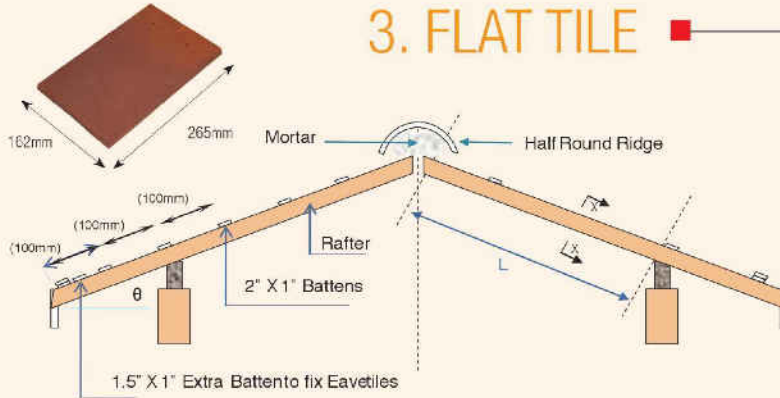

Minimum roof angle (θ) = 30°

Tile Specifications

	Plain Tile	Half Round Ridge
Length (mm)	265±3	300±3
Width (mm)	162±3	240±3
Effective Length (mm)	85 to 100	300±3
Effective Width (mm)	162±3	240±3
Unit Weight (g)	1200±50	3400±50
Transverse Breaking Load (N)	>900	>900
Coverage	562 pcs. Per 100 sq. Feet	1 pcs. per foot
Water Absorption (%)	< 10	< 10

Rafter Specifications

Rafter Section	4" X 2"	5" X 2"	6" X 2"
Roof Angle(θ)	Rafter Span (L)		
30° Minimum	8'	8' to 10'	8' to 12'
30° and above	8'	8' to 10'	8' to 12'

ACCESSORIES



4. ROMAN TILE

ACCESSORY



RIDGE TILE-S2

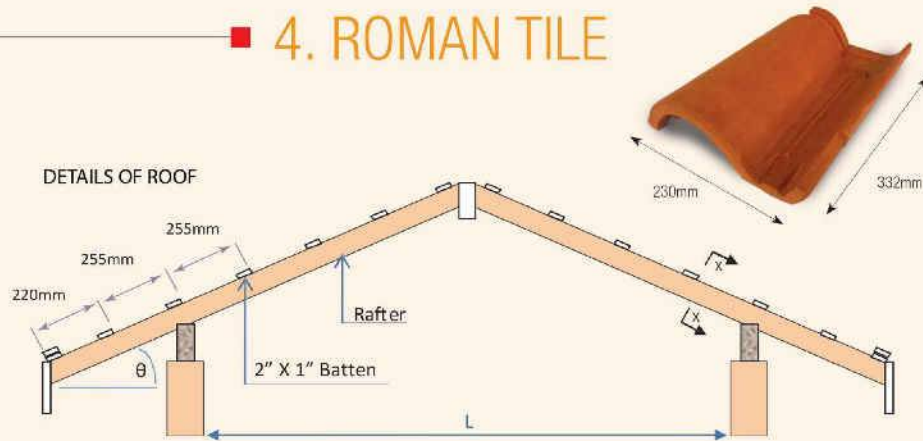

Minimum roof angle (θ) = 25°

Tile Specifications

Length	332±2mm
Width	230±2mm
Effective Length	255 ±2mm
Effective Width	178±2 mm
Unit Weight	2550±50 g
Transverse Breaking Load	Above 1000 N/mm ²
Coverage	205 pcs. Per 100 sq. Feet.
Water Absorption	Less than 10%

Rafter Specifications

Rafter Section	4" X 2"	5" X 2"	6" X 2"
Roof Angle(θ)	Rafter Span (L)		
25° Minimum	8'	8' to 12'	8' to 12'
25° and above	8'	8' to 12'	8' to 12'

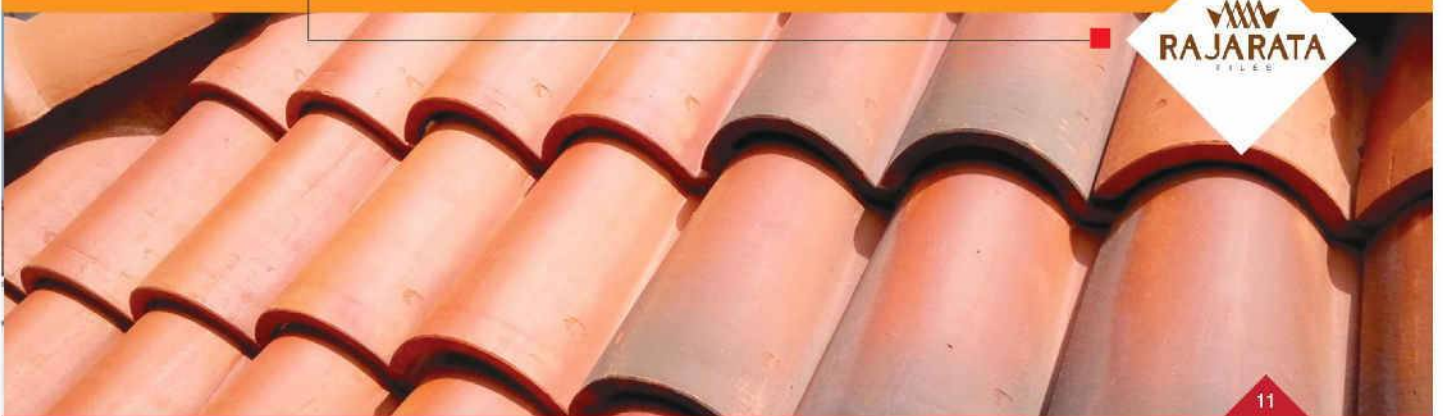

RAJARATA
TILES

5. COVERING TILE

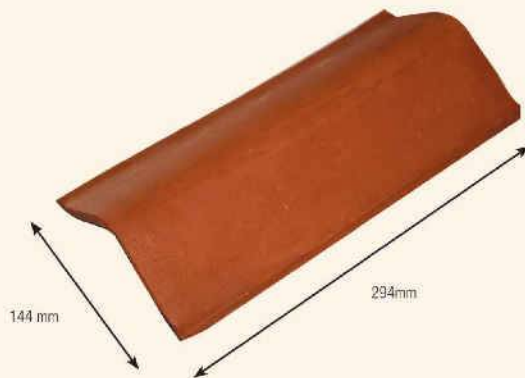

Tile Specifications

Length (mm)	298.0 ± 2.0
Width (mm)	144.0 ± 4.0
Effective Length	275.0 ± 2.0
Thickness (mm)	10.0 ± 0.2
Unit Weight (g)	1150.0 ± 50.0
Transverse Breaking Load	> 1000Nm
Water Absorption (%)	< 10
Coverage	225 pcs per 100 sqft
Water Permeability > 24 hrs.	PASS

**RAJARATA**
TILES

6. HELA TILE



Natural



Off White



Autumn Blend

ACCESSORY



HOGS BACK

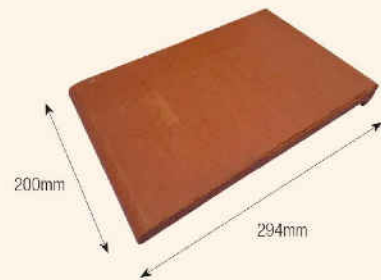

Tile Specifications

Length (mm)	294 ± 3
Width (mm)	200 ± 3
Thickness (mm)	16.0 ± 0.5
Unit Weight (g)	1.950g ± 50g
Transverse Breaking Load	≥ 1000 N/mm ²
Coverage	357 pieces per 100 sq feet
Water Absorption (%)	≤ 9 %

Rafter Specifications

Rafter Section	4" X 2"	5" X 2"	6" X 2"
Roof Angle(θ)	Rafter Span (L)		
30° Minimum	8'	8' to 10'	8' to 12'
30° and above	8'	8' to 10'	8' to 12'
Rafter Gap	18"	18"	18"

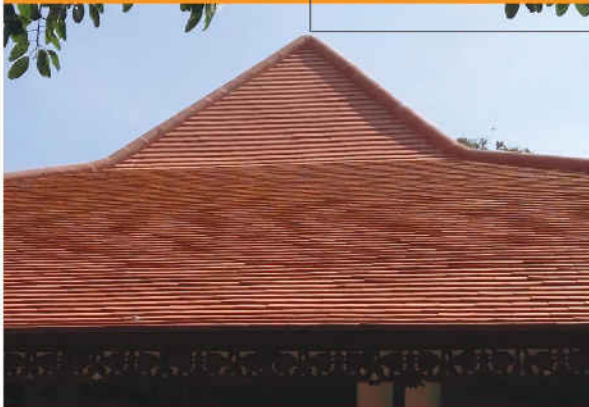

RAJARATA
TILE

7. TERRACOTTA FLOOR TILE

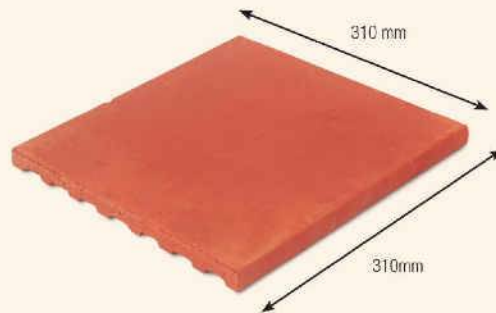

Tile Specifications

Length (L) (mm)	310.0 ± 3
Width (mm)	310.0 ± 3
Thickness (mm)	15.5 ± 0.5
Coverage	97 pcs. Per 100 Sq feet
Joint Thickness (mm)	15.0
Water Absorption	< 10 %
Compressive Strength (N/mm ²)	>1200
Weight (g)	3450 ± 50



OUR ACHIEVEMENTS



1. Certificate for - ISO 9001: 2008 / SLS ISO 9001: 2008
2. Authorized certificate for site & premises
3. National Business Excellence Awards 2014 - Certificate
4. CNCI Achiever Award - 2015
5. National Business Excellence Awards 2014 - Trophy
6. CNCI Achiever Gold Award - 2015 - Provincial Level
7. CNCI Achiever Silver Award - 2015 - National Level
8. Green Labelled Product - 2016 -2019

RAJARATA
FILE

MANUFACTURING PROCESS



Clay Heap



Clay Transportation



Primary Clay bins



Box Feeders



Packing



Sorting & Coating



Fired Tile Unloading



Tunnel Kiln Firing

**RAJARATA**
TILES

- The largest state-of-the-art clay tile manufacturing plant in Sri Lanka
- Globally accepted Japanese Technology
- Monthly production capacity of 500,000 tiles
- All clay tile styles meet international standards

■ MANUFACTURING PROCESS



Secondary Clay Bins



Forming Line



Screen Feeder



Bats Extrusion



Kiln Control Room



Main Dryer



Natural Dryer



S1 Production Line



ICONIC PROJECTS

Mr. Aravinda De Silva - Residence



RAJARATA
FILES



■ **ICONIC PROJECTS**
The crown of every luxury

Cinnamon Bey- Beruwala

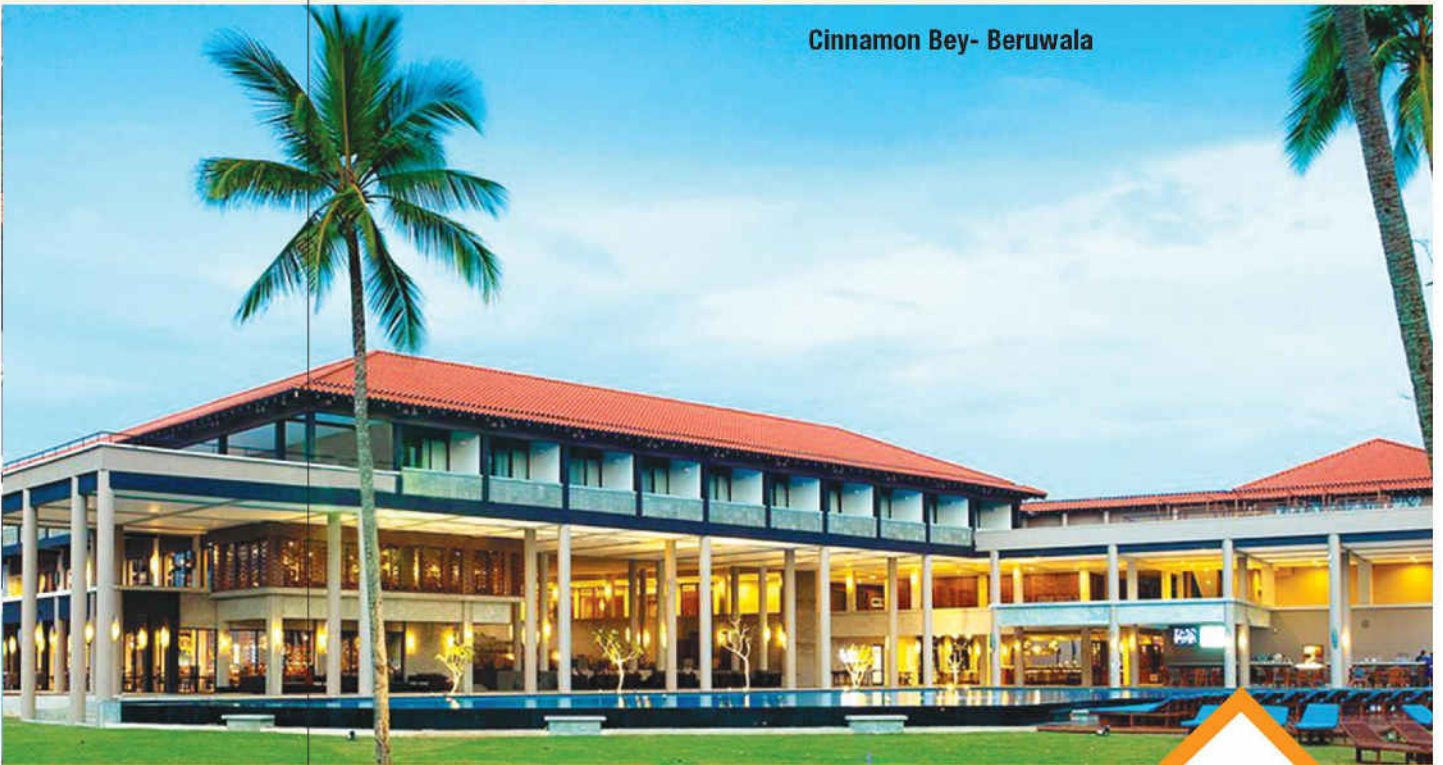

ICONIC PROJECTS

Shielding every comfort zone

Lanka Sportreizen - Pasikuda





RAJARATA
FILES

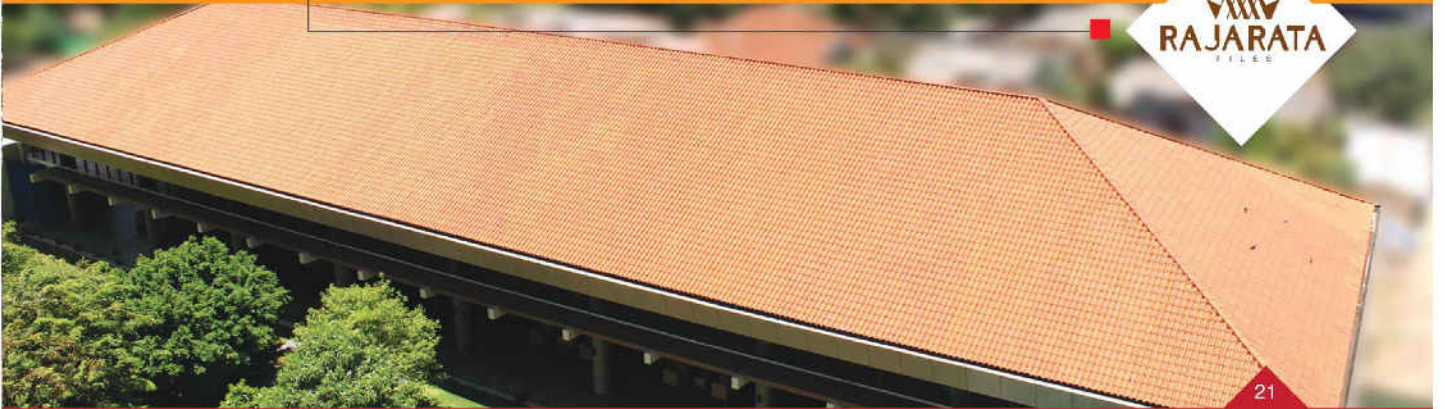

■ **ICONIC PROJECTS**
Adorning the skyline

Anantara Peace Haven - Tangalle



ICONIC PROJECTS

An authentic resemblance of heritage

Forest Rock Garden - Anuradapura

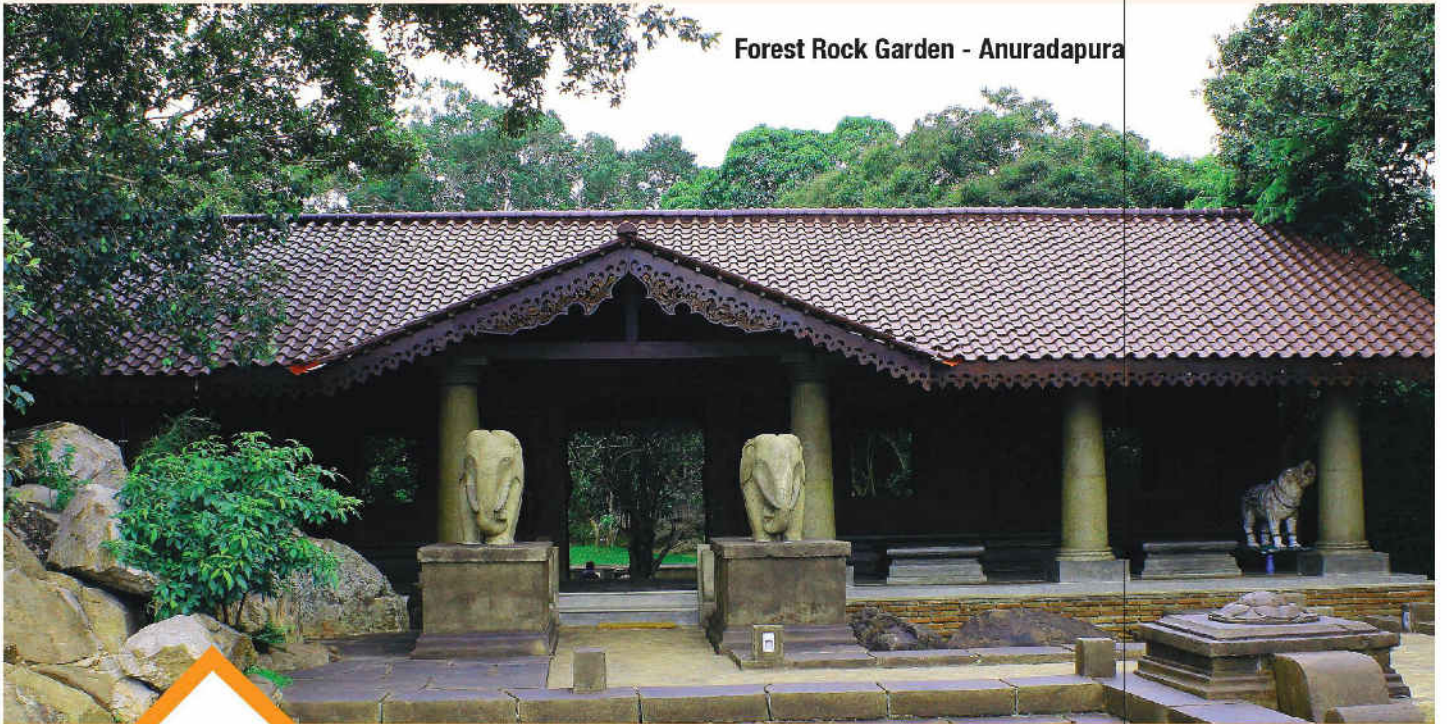

RAJARATA
VILLAS



22



■ **ICONIC PROJECTS**

Uncovering your class

Mr. Madanayake's Residence - Col 07



RAJARATA
FILEE



ICONIC PROJECTS

An authentic resemblance of heritage

Homeplus Contractors & Builders

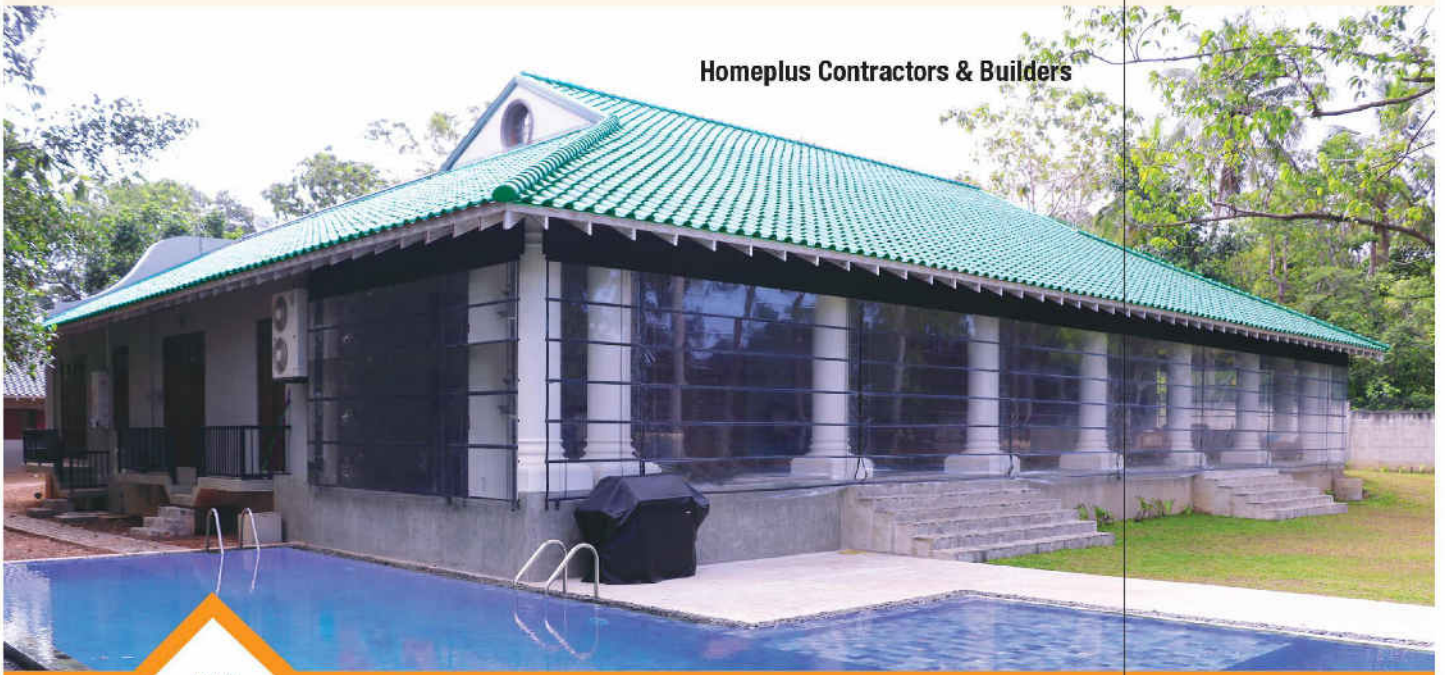

RAJARATA
FILED



GRANDEUR OF A REMARKABLE

PROJECTS ■

1. **Cape Resort** - Weligama
2. **Shangri-La** - Hambantota
3. **Ananthara** - Pasikuda
4. **Ananthaya** - Tangalle
5. **UTMT** - Dehiwala
6. **LSR** - Pasikuda, Dambulla, Bentota
7. **Cinnamen Bay** - Beruwala
8. **Havelock City** - Kirulapone
9. **Thaulla Resort** - Tissamaharama
10. **Forest Rock Garden** - Anuradhapura
11. **Paragon Aurveda** - Koggala
12. **On Houses** - Weligama
13. **Crow Island** - Mattakkuliya
14. **KCC** - Kandy
15. **Seerock Boutique & Spa Hotel** - Sigiriya ■

HOUSES ■

1. **Mr. Susantha Rathnayake**
- Chairman/ CEO - John Keells Holdings PLC
2. **Mr. Ranjith Pandithage**
- Chairman/ CEO - Diesel & Motor Engineering PLC (DIMO)
3. **Mr. Muruganathan**
- Chairman - Melwire Rolling (Pvt) Ltd. (Melwa)
4. **Mr. Mahendra Jayasekara**
- M/D - Lanka Tiles PLC
5. **Mr. Dhammika Perera**
- Chairman - Royal Ceramics Lanka PLC (Rocell)
6. **Mr. Sanjeeva Rajarathnam**
- M/D - Lankem Ceylon PLC
7. **Mr. Milfer Makeen**
Chairman - Macksons Holdings
8. **Mr. Eastman Narangoda**
- Chairman - Soylan Bank
9. **Mr. Nihal Senevirathna**
- Chairman - Neth FM
10. **Mr. Rohan De Silva**
- Chairman - Macbertan (Pvt) Ltd.
11. **Dr. M.N.M. Najeebdeen**
- CEO/ Chairman - Deen Brothers
12. **Mr. Gayan Heenkenda**
- Basnayaka Nilame - Sri Natha Devalaya - Kandy.
13. **Mr. Aravinda De Silva** - Cricketer
14. **Mr. Kumar Sangakkara** - Cricketer
15. **Mr. Angelo Mathews** - Cricketer
16. **Ms. Malini Fonseka** - Artist
17. **Ms. Anoja Weerasinghe** - Artist
18. **Mr. Sriyantha Mendis** - Artist
19. **Mr. Bhathiya Jayakody** - Artist
20. **Mr. Weeraratna** - Bake House ■



Samson Rajarata Tiles (Pvt) Ltd - DSI COMPLEX

251, High Level Road, Navinna, Maharagama, Sri Lanka.

Hotline: 0777 815 520, 0777 815 316

Tel: +94 (0)11 4815423, 4621813 Fax: +94 (0)11 2851730

E-mail: info@dsitiles.com

Web: <http://www.dsitiles.lk/>

 <https://www.facebook.com/dsiroofingtiles>

