



**Viaplant is looking
for Sales Partners
and Distributors**



VIAPLANT

Viaplant is a Hungarian design company, that has developed a unique, plant based material of appealing visual aesthetics for interior, furniture and fashion design installations.

Already present on four different markets and with ambitious expansion plans, Viaplant is currently looking for Sales Commission Agents and Distributors ideally with Showroom, to launch its product range of lighting installations and design furniture.

The Viaplant story

Started as a project of a team of engineers and designers working for a landscape architecture studio active on the market for over 20 years, followed by an extensive 3 to 4 years research and development period, the company has gradually developed a unique, plant based material called Viaplant and as a result the brand has been born.

This very special and unique material called Viaplant is made from a fine selection of 12+ different plant residuals and manufactured with a proprietary engineering technique that preserves the plant component inside the material, displaying a vast variety of natural colours and textures and creates abstractions, artistic details.

We would like to connect with Sales Agents and Distributors with relevant experience in the lighting industry // curated design products // architecture and interior design // or active in the premium goods market sector.

Viaplant principles, innovation and specific qualities

PLANT- NATURE

As a form of up-cycling, during the manufacturing process of the light and furniture collection, the company is making use of plant parts generated and discarded during the maintenance of urban green spaces, generally leaves and flowers, whose regeneration cycle is one year or less. The Plant-Nature line forms a very strong ethos of the company.

HERITAGE

The entire plant sourcing and manufacturing of the material and product line is carried out locally in Hungary and preserves the heritage of its natural origin. Therefore the end product, i.e. lamps and furniture exhibits a strong presence and offers an exciting story telling surface via a multitude of real plant textures and colour variations.

DESIGN

From an architectural perspective the material can also be made available as wall tile, cover panel, table top or a standalone material to be used in various shape and form by individual interior designers or in architectural installations. As stated earlier, the plant component inside preserves a vast variety of natural colours and textures that creates abstractions and artistic details.

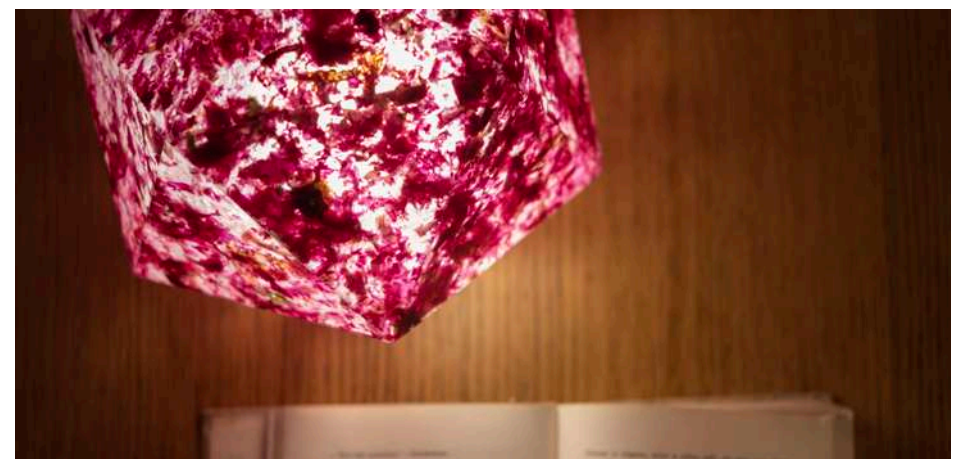



Viaplant have recently exhibited on trade show events at London Design Fair (2019), at MAISON&OBJET trade show in Paris (2020) and MosBuild Awards in Moscow (2020), where the brand won the audience and the professional jury award.

Following the positive feedback from recent international **trade show events** and the launch of the Viaplant **products on five different markets** in the last year, the company decided to continue with the ambitious expansion plan and is currently looking for Sales Partners to support in the market launch, business development and sales of the light and furniture collection products.

Target market

The target market is the **design oriented customer**, in form of individual customer or in the B2B sector.

The company is currently marketing and selling the lighting and furniture collection to individual customers, to interior designers and architects as well as to the B2B sector for residential, office or common space, to the hotel and restaurant sector and property developers.

In the B2B sector we are typically looking at showrooms, interior designers, property developers, architecture studios or designers working with hotels, restaurants or any form of architectural planning where the use of a new and innovative material is highly thought after and in constant need by the industry.

The key product line of lighting and furniture collection can be used in residential surrounding, in professional office or corporate settings (i.e lounge), but also in architectural planning that can make use of either the end products i.e. lamps and furniture or by applying this special material in various architectural installations, such as wall tiles, counter top, etc.

Viaplant is looking for Business Partners

The company is looking for Sales Partners, Distributors, Showrooms to gradually build up presence across a number of surrounding markets and make contact with potential customers in the B2B sector, but also to reach out and raise interest in the B2C end customer segment.

Commercial agreements and Business Partnering

- **Sales Agents** to creatively market Viaplant products to distributors, showrooms, retailers or B2B end customers, key players in the property development -office or residential and the hotel or restaurant sector and represent the brand on the given market
- **Distributors** (ideally with a Showroom) to represent the brand and actively market the company's products to wholesalers, retailers or potential B2B and B2C end customer, depending on the distributor profile
- **Showrooms** to exhibit and promote the Viaplant brand for B2C and B2B customers



Contact us!

For further reference please visit our website:

www.viaplant.com

or please see our catalogue with product details:

[Viaplant catalogue](#)

Should you be interested in representing Viaplant products on your market and take part in this exciting journey, then please contact us via email:

viaplant@viaplant.com

We look forward to meeting You!

The Viaplant Team

V I A P L A N T

LIGHTING AND FURNITURE COLLECTION

COLUMNA
TABLE LAMPS

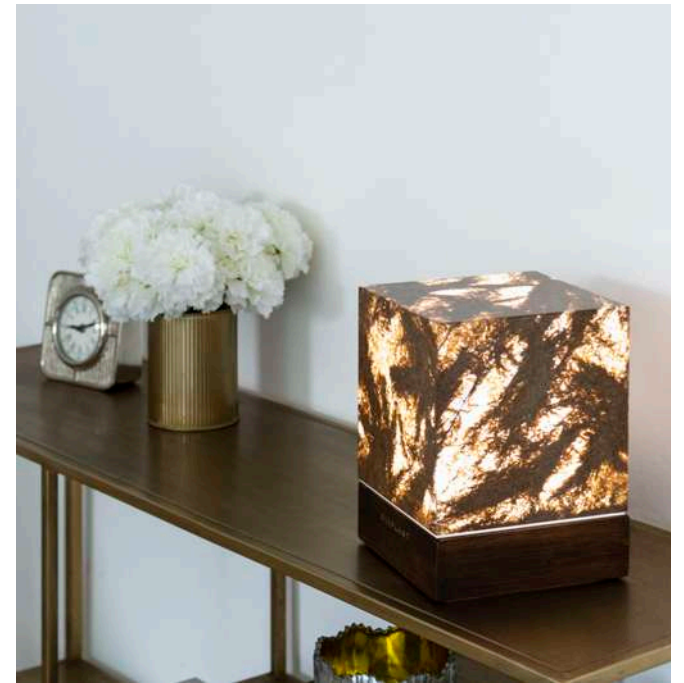
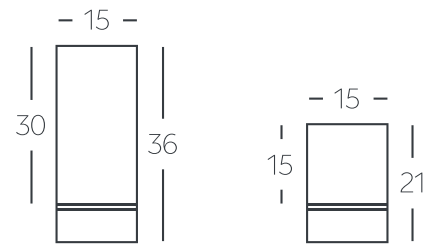
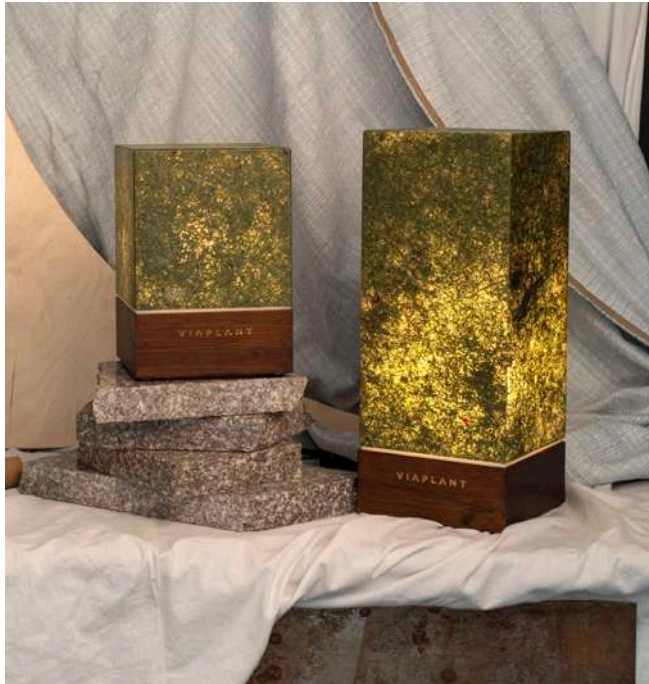

COLUMNA
FLOOR LAMPS

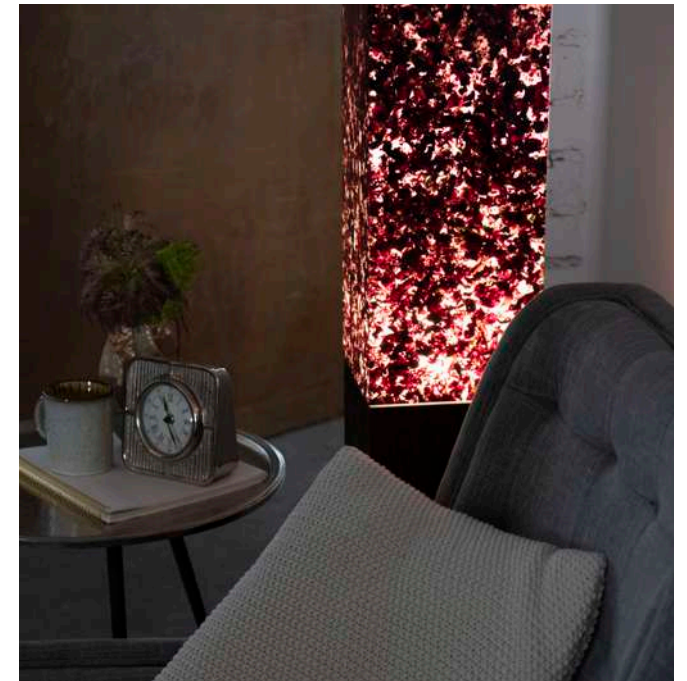
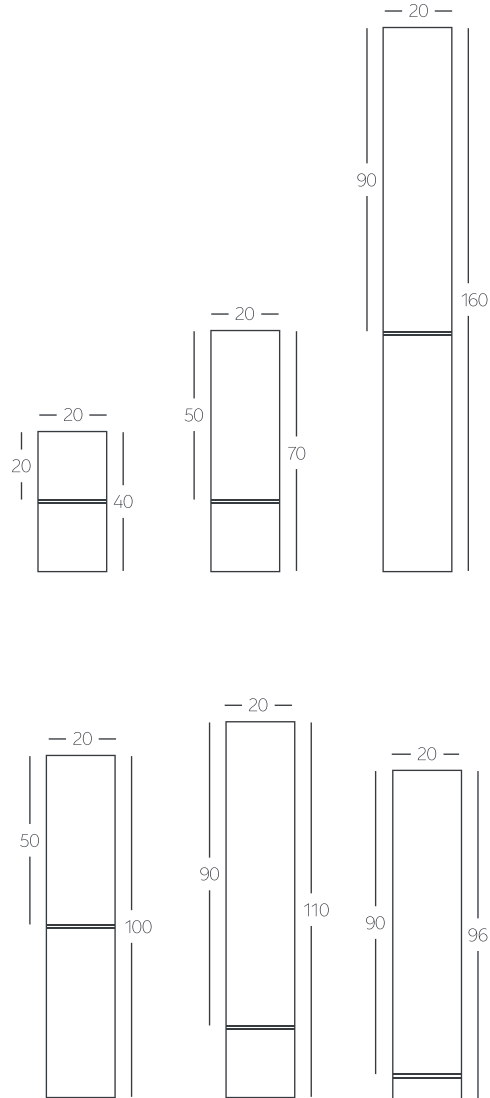

COLUMNA
ILLUMINATED FURNITURE

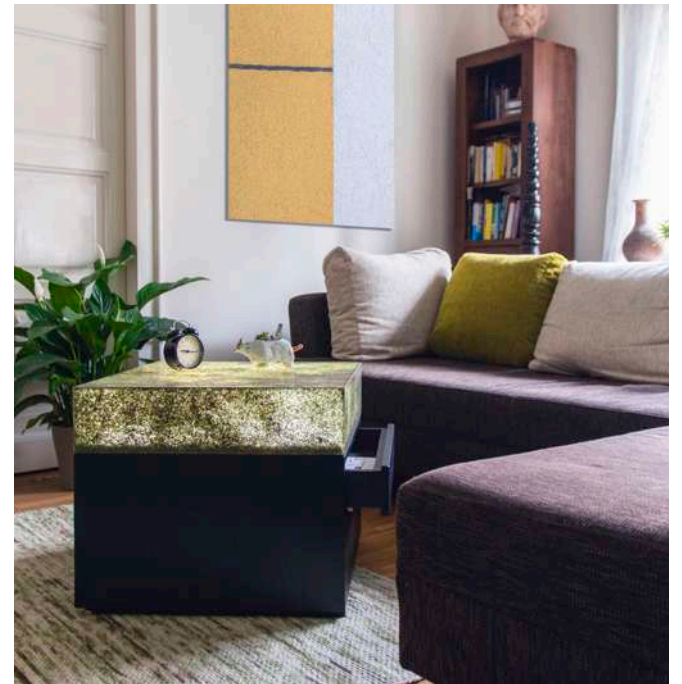
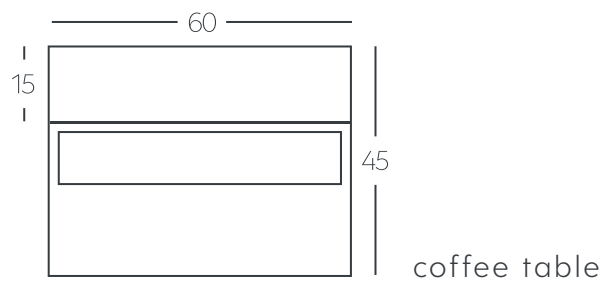
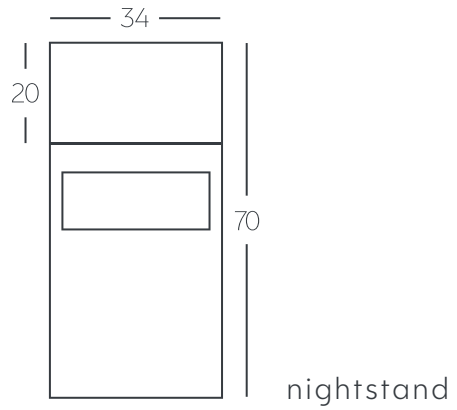

HEDRON
TABLE / FLOOR LAMPS

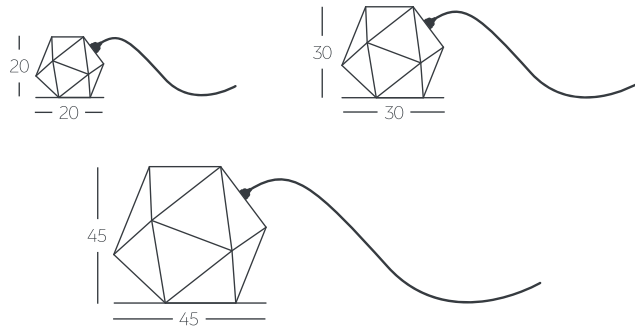
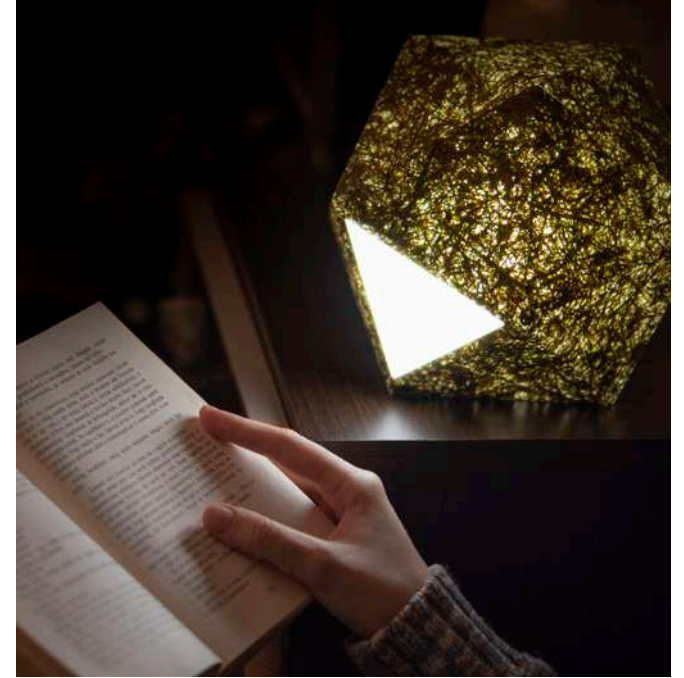

HEDRON
PENDANT LAMPS

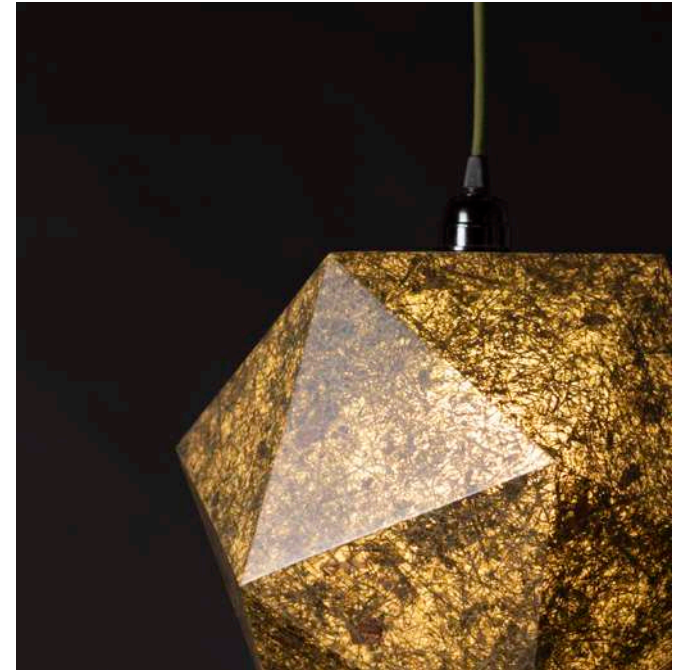
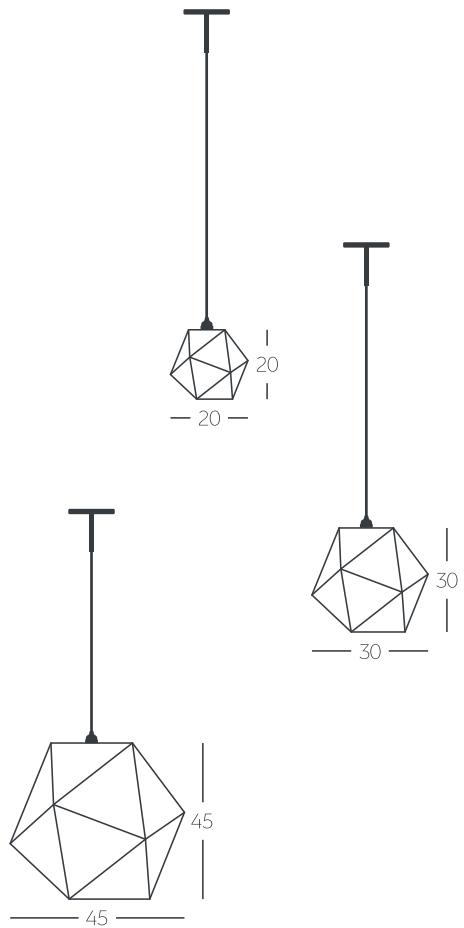

OBLIQ
ILLUMINATED FURNITURE

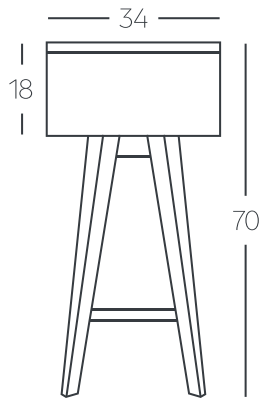

nightstand

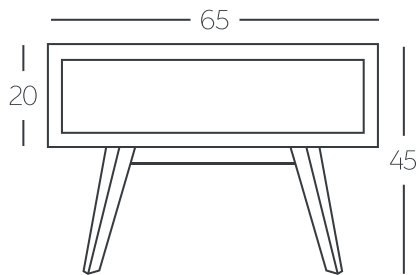

coffee table



QUADRUM
WALL LAMPS

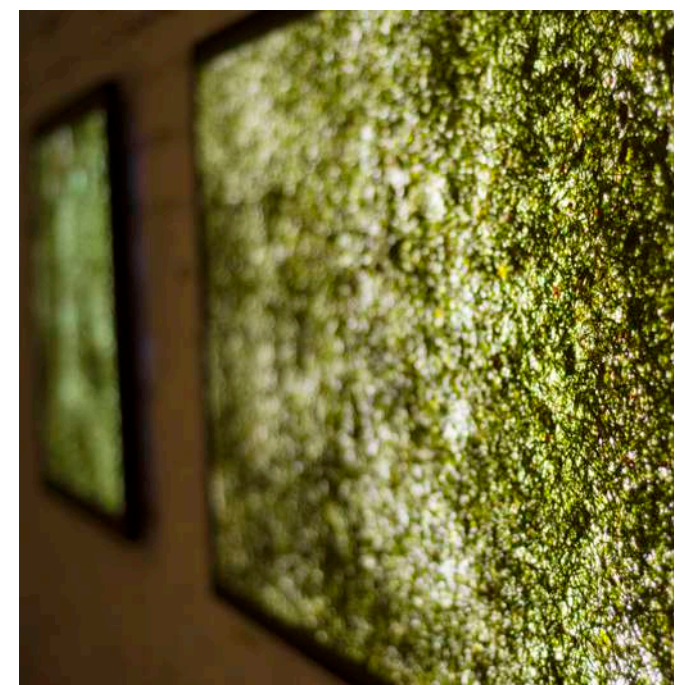
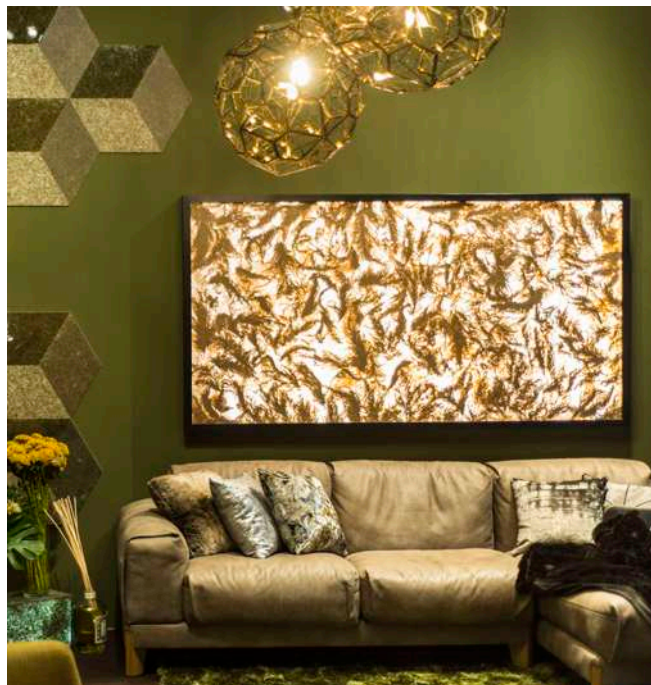
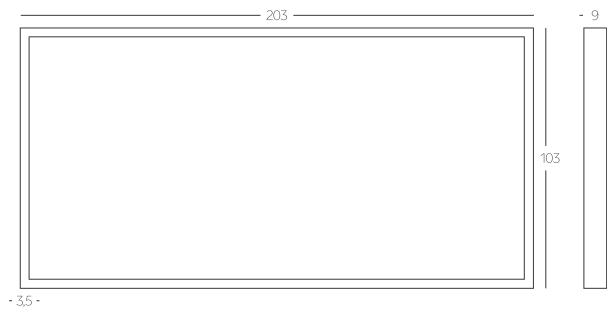
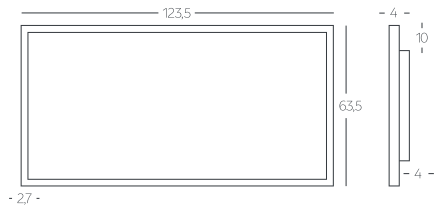
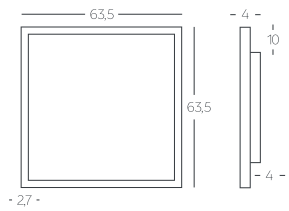

QUADRUM ART
WALL LAMPS

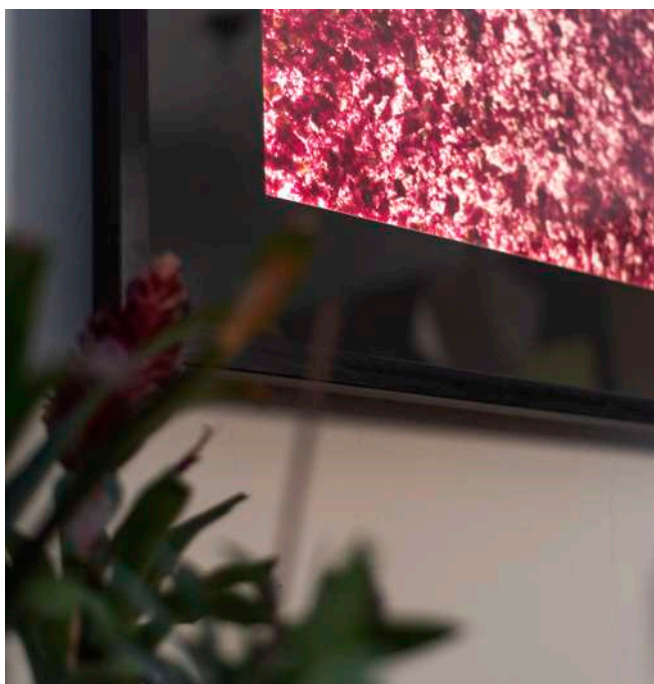
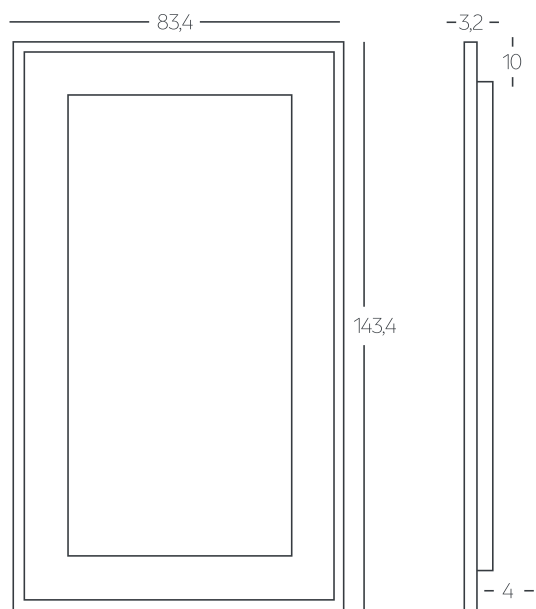

QUADRUM LEAN
FLOOR LAMPS

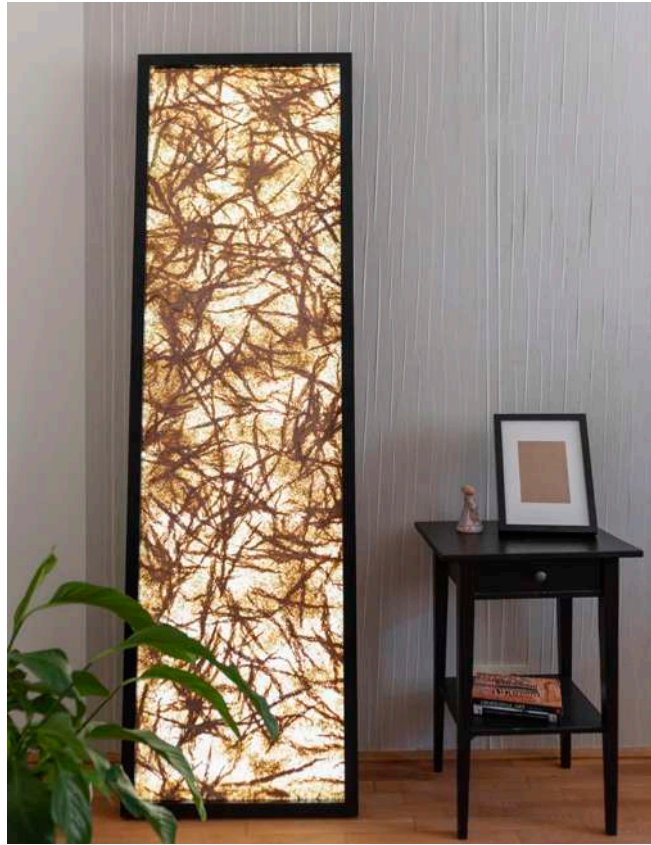
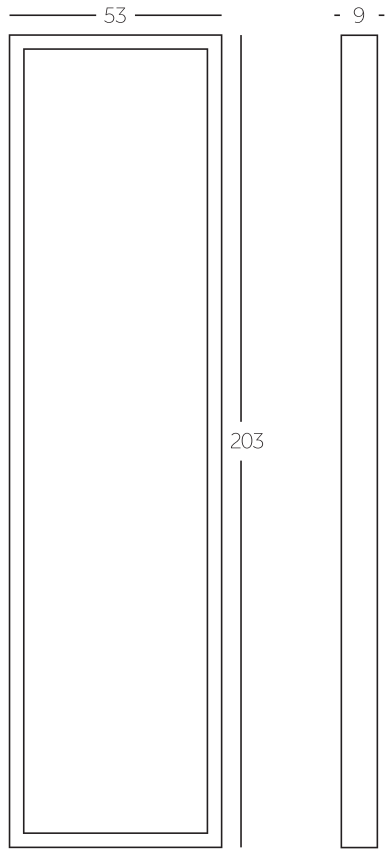

www.viaplant.com

viaplant@viaplant.com

mobil: +36 20 257 7040

HQ / showroom / postal address:

Hungary, 1136 Budapest, Hegedűs Gyula u. 15.