

Delegation Information

Company Name	BNR Exports
Contact Person	Mr. B R Mohan
Title	Managing Director
Address	Plot No. 125-126, Jigani Link Road, Ivth Phase, Bommasandra Indl. Area, Bangalore-560099
Tel	91-80-27833420/27833705
Fax	91-80-27833509
E-Mail	mohan@bnr-group.com
Website	www.bnr-group.com
Annual Export Trunonver in 2007~08	1.12 million (US\$)
Countries of Exports	European Countries, Australia, USA
Accreditation Standard	ISO 9001-2000
Broad Category	Machined parts
HS Code	85371000/85389000/85044090/490314900
Product/Service Info	Precision Components, Machined Ferrous and Non-Ferrous Castings, Machined Forgings
Usage of product	Non Ferrous Metal & products; Aircraft & Spares., Automobile Parts, Ferrous Industrial Castings and Aluminium & Products thereof
Remarks	- 첨부 사진 참조 - 자세한 사항 및 모든 제품 정보는 홈페이지 참조

※ **BNR Exports Item**

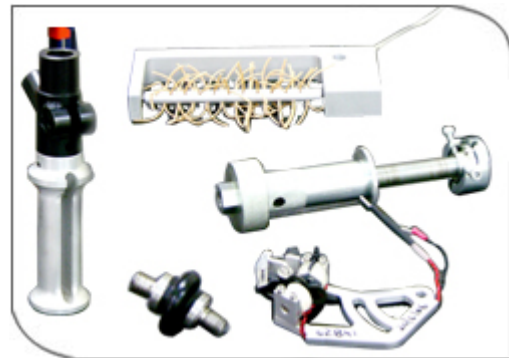
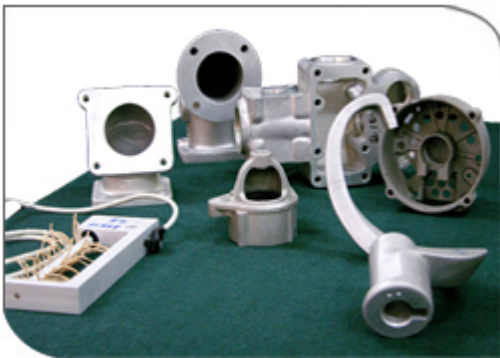
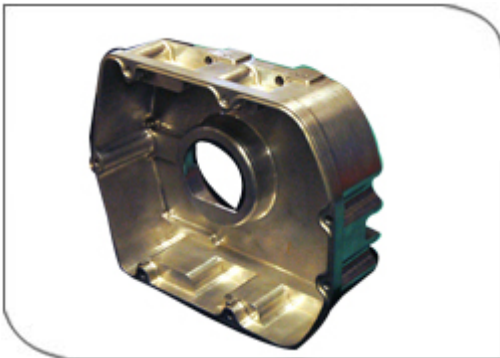
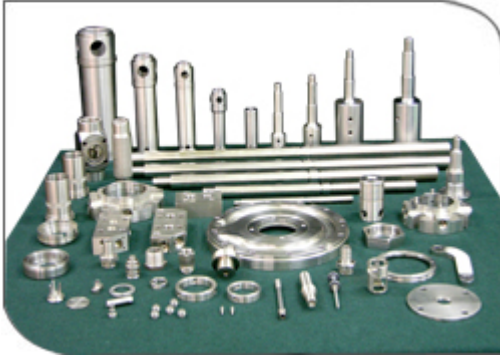

Delegation Information

Company Name	Brother Sales (India)
Contact Person	Mr. Ravi Kumar
Title	Technical Manager
Address	1st Floor Aggarwal Marble & iron Store, Hira Colony Road, Hoshiarpur
Tel	91-1882-657404
Fax	91-1882-503495
E-Mail	bsi_expo2005@yahoo.com
Website	
Annual Export Trunonver in 2007~08	(US\$)
Countries of Exports	European Country
Accreditation Standard	
Broad Category	Hand Tools
HS Code	8201/8202/8203/8204/8205/8206
Product/Service Info	Hand Tools
Usage of product	Agricultural farming activities and companies associated with the sue of hand tools, hand saws, spanners, screwdrivers, wrenches, etc
Remarks	

Delegation Information

Company Name	Durga Sales Corp.
Contact Person	Mr. Satnam Singh
Title	Marketing Manager
Address	1st Floor, Mazra Complex, Khadr Bhandar Wali gali, Mahilpur, Hoshiarpur-146105
Tel	91-1884-246033
Fax	91-1884-248185
E-Mail	durgasales2001@gamil.com
Website	
Annual Export Trunonver in 2007~08	(US\$)
Countries of Exports	European Country
Accreditation Standard	
Broad Category	Hand Tools
HS Code	8201/8202/8203/8204/8205/8206
Product/Service Info	Hand Tools
Usage of product	Agricultural farming activities and companies associated with the sue of hand tools, hand saws, spanners, screwdrivers, wrenches, etc
Remarks	

Delegation Information

Company Name	Dynamic Valves P Ltd
Contact Person	Mr. Nagesh Soparkar
Title	Managing Director
Address	R-353 Rabale, M.I.D.C.,
Tel	91-22-2769 2277
Fax	91-22-2769 2154
E-Mail	dvpl@vsnl.net
Website	www.dynamicvalves.com
Annual Export Trunonver in 2007~08	(US\$)
Countries of Exports	
Accreditation Standard	ISO 9001-2008
Broad Category	Industrial valves
HS Code	848180
Product/Service Info	Butterfly Valves upto 2400 mm manufactured with special features, viz., lke double eccentric disc, low torque (steel back PTFE Bush)
Usage of product	Valves are generally fitted with all types of quality operators like Gear Box & Hand wheel, Electric Actuaiores, Pneumatic Actiatirs, Hydraulic actuators, tec
Remarks	- 첨부 사진 참조 - 자세한 사항 및 모든 제품 정보는 홈페이지 참조

※ Dynamic Valves Item

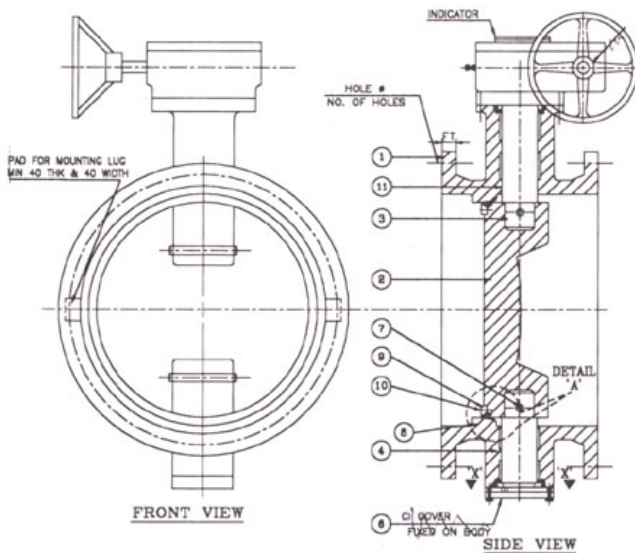
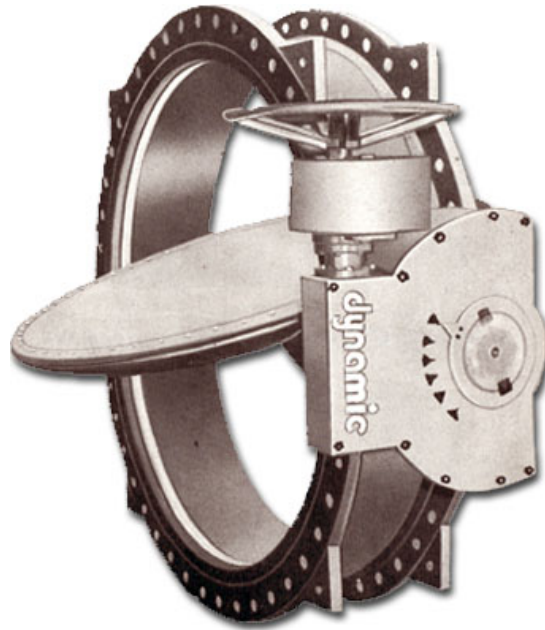

11	SHAFT SEAL	NITRILE RUBBER
10	INTERNAL HARDWARE	AISI 304
9	CLAMPING RING	AISI 304
8	SEAT	AISI 304
7	PINS	AISI 304
6	COVER	C.I.
5	DISC SEAL	EPDM RUBBER
4	BUSH	STEEL BACK PTFE
3	SHAFT	ST STEEL GR 304
2	DISC	SG IS1885 GR 500/7
1	BODY	CI IS210 FG300
Part No.	DESCRIPTION	MATERIAL
BILL OF MATERIAL		

Delegation Information

Company Name	M.E ENERGY PRIVATE LIMITED
Contact Person	KARTHA KALATHIL VIJAYSANKER
Title	Managing Director
Address	205, LAXMI PLAZA, MUMBAI-PUNE ROAD, DAPODI, PUNE 411 012
Tel	91-20 27147705
Fax	020 27147710
E-Mail	kvkartha@meenergy.co.in
Website	www.meenergy.co.in
Annual Export Trunonver in 2007~08	0.4 million (US\$)
Countries of Exports	Middle East and South East Asia
Accreditation Standard	ISO : 9001-2000; ASME "u" Stamp
Broad Category	Electrical machinery & Equipment
HS Code	73090040/841861/84191900/84691100
Product/Service Info	Waste Heat Recovery Systems / Exhaust Gas Boilers / Heat Exchangers / Pressure vessel
Usage of product	Process Industries, Energy Saving, Marine application
Remarks	- 첨부 사진 참조 - 자세한 사항 및 모든 제품 정보는 홈페이지 참조

※ M.E Energy Private Item

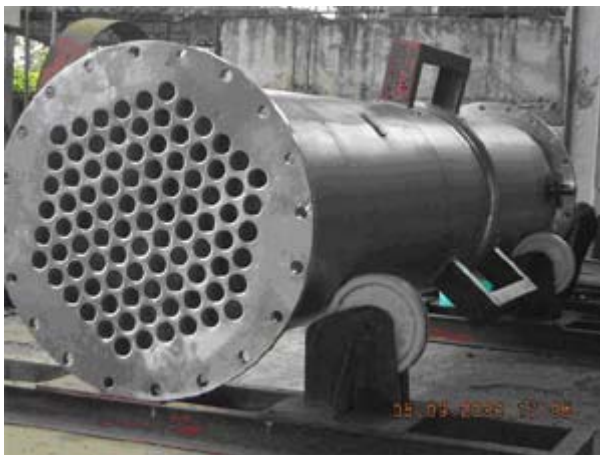

Delegation Information

Company Name	Manko Industries
Contact Person	Mr. K. S. Jain
Title	General Manager
Address	S-27, Industrial Area Jalandhar 144 004
Tel	91-0181-2290-771
Fax	0181-2290-554
E-Mail	manko@vsnl.com
Website	www.mankoind.com
Annual Export Trunonver in 2007~08	0.21 million (US\$)
Countries of Exports	USA, UK, Australia, New Zealand & Sri Lanka
Accreditation Standard	ISO/TS:16949:2002 ISO:9001:2000
Broad Category	Non Ferrous Machined Components viz. Bushings, Bearings, Thrust Washers, Brake Discs etc.; and Trailer Components viz. Hubs, Disc Hubs, Rotors, Axles, Couplings and other fabricated parts for use in the manufacture of Box and Boat trailers
HS Code	7419.99.00; and 8714.94.00
Product/Service Info	Bushes & Non-ferrous Component
Usage of product	Automobile, tractors, submersible pumps, heavy machinery & machine tools
Remarks	- 첨부 사진 참조 - 자세한 사항 및 모든 제품 정보는 홈페이지 참조

※ **Manko Industries Item**



Delegation Information

Company Name	Metal Power Analytical (I) P. Ltd.
Contact Person	Mr. P. D. Pant,
Title	Managing Director
Address	C-46, Raj Indl. Complex, Military Road, Marol, Andheri – East Mumbai 400 059
Tel	91-22-2925-0321/1399
Fax	022-2925-1373
E-Mail	metpower@vsnl.com
Website	www.metpowerin.com
Annual Export Trunonver in 2007~08	184,739 (US\$)
Countries of Exports	Congo, Ethiopia, Kenya, Malaysia, Mauritius, Nepal, Oman, Pakistan, Serbia, Sri Lanka, Sudan
Accreditation Standard	ISO:9001:2000
Broad Category	Mettalurgical Industry
HS Code	902730
Product/Service Info	Optical Emission Spectrometers
Usage of product	Metal making industry, Forging, automobiles, railways, defence--all metals related industries & laboratories
Remarks	- 첨부 사진 참조 - 자세한 사항 및 모든 제품 정보는 홈페이지 참조

※ Metal Power Analytical Item

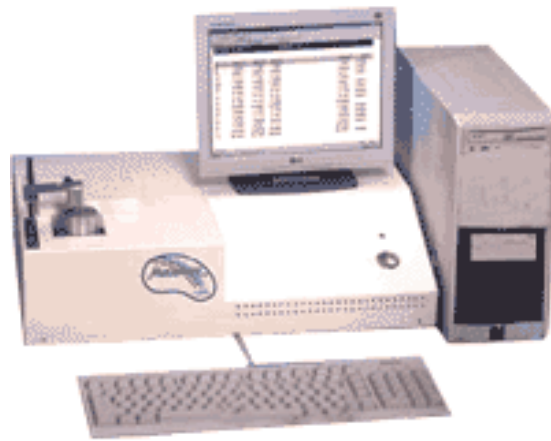

Delegation Information

Company Name	Naraiuran Controls (India) Pvt Ltd
Contact Person	Mr. Jeeva Ramaswamy
Title	Manager International Business
Address	Chennai
Tel	91-44-26584666/26584777
Fax	91-44-26584700
E-Mail	ravi@naraiuran.com jeeva.subhaiya@naraiuran.com
Website	www.naraiuran.com
Annual Export Trunonver in 2007~08	131,700(US\$)
Countries of Exports	Middle East and South Asia
Accreditation Standard	ISO 9001-2000
Broad Category	Engineering Design Consultancy
HS Code	85371000/85389000/85044090/90314900
Product/Service Info	Automation Control Panels/Design engineering Supply & commissioning of Electrical Automation projects/ Retrofit Works/ Process Instrumentation/ LT. MOC Panels
Usage of product	All kinds of electrical/automation project and infrastructure projects
Remarks	- 자세한 사항 및 모든 품목 정보는 홈페이지 참조

Delegation Information

Company Name	Rotofilt Engineers Limited
Contact Person	Mr. Kishor H. Makvana
Title	Managing Director
Address	Plot No. 102, Phase-I, Op Torrent Sub Station, GIDC, Vatva, Ahmedabad-382445
Tel	91-79-25899601-605
Fax	91-79-25899607/608
E-Mail	rotofilt@rotofilt.com
Website	www.rotofilt.com
Annual Export Trunonver in 2007~08	(US\$)
Countries of Exports	EU, Africa and SAARC
Accreditation Standard	ISO 9001-2000 and CE marking
Broad Category	Solution Provide for Solid-Liquid separation
HS Code	84211991/84211999/84211950
Product/Service Info	Pusher Centrifuges, Decanters,
Usage of product	Their products can be used in pharmaceuticals, food processing, waste processing, effluent treatment, minerals, chemical processing
Remarks	- 첨부 사진 참조 - 자세한 사항 및 모든 품목 정보는 홈페이지 참조

※ Rotofilt Engineers Item



Delegation Information

Company Name	Shree Forgings
Contact Person	Mr. H S Divakar
Title	CEO
Address	Bangalore
Tel	91-80-26740332
Fax	
E-Mail	shreeforgings@vsnl.net
Website	www.shreeforgings.com
Annual Export Trunonver in 2007~08	(US\$)
Countries of Exports	
Accreditation Standard	ISO 9001-2000
Broad Category	Industrial Fastners
HS Code	73181500/ 73181600/73182200/73181900/73182300
Product/Service Info	Industrial Fastners
Usage of product	Automobile, Electrical, Electronic and Aerospace industries
Remarks	- 첨부 사진 참조 - 자세한 사항 및 모든 품목 정보는 홈페이지 참조

※ **Shree Forgings Item**



Delegation Information

Company Name	Singa Engineering and Trading
Contact Person	Mr. T. S. Murthy
Title	Proprietor
Address	Second Floor, Plot No. 46, E. C. Extension, Kushaiguda Hyderabad 500 062
Tel	91-40-2713-6932
Fax	040-2713-6933
E-Mail	singaengineering@yahoo.com.sg
Website	
Annual Export Trunonver in 2007~08	26,577 (US\$)
Countries of Exports	Singapore
Accreditation Standard	
Broad Category	Mining Industry
HS Code	843041 and 843050
Product/Service Info	Mining and Drilling Equipment
Usage of product	Borewells, water well drilling and piling and industries where drilling is required
Remarks	- 첨부 사진 참조

※ **Singa Engineering and Trading Item**



Delegation Information

Company Name	Ultimate Alloys (P) Ltd.
Contact Person	Mr. G.Ezhil
Title	Director
Address	S.F. No. 138/1-A.B.C. Kannampalayam Village Trichy Road, Sulur Palladam TK Coimbatore 641 402
Tel	91-42202681-728/2688-066/345
Fax	0422-2689-598
E-Mail	Ezhil@ultimatealloys.com
Website	www.ultimatealloys.com
Annual Export Trunonver in 2007~08	0.5 million (US\$)
Countries of Exports	Germany, Swiss and U.K.
Accreditation Standard	ISO:9001:2000, IBR
Broad Category	Castings
HS Code	73259930
Product/Service Info	Steel Castings Machined
Usage of product	In valves, pump industries and machinery parts
Remarks	- 첨부 사진 참조 - 자세한 사항 및 모든 품목 정보는 홈페이지 참조

※ **Ultimate Alloys Item**

